

LED cabinet light with hand scanning motion sensor

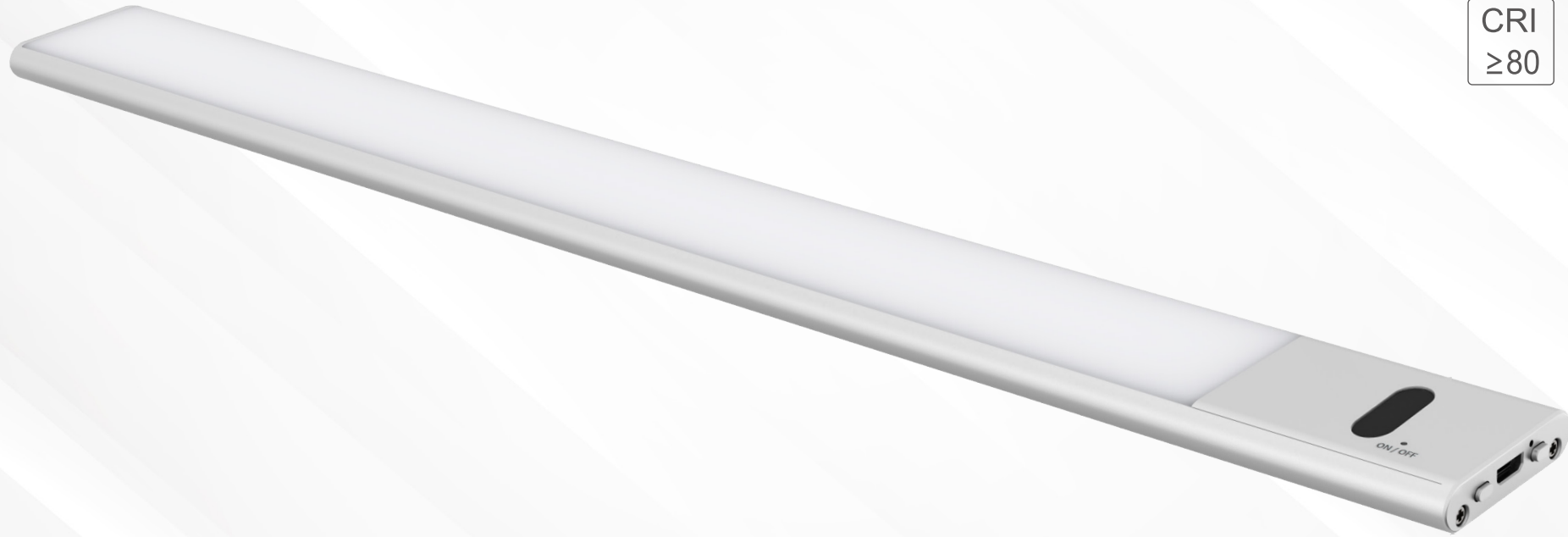



CRI
≥80

CE

Warranty
3 years

 Easy
to install

 USB
rechargeable

 Motion
sensor

 Not
glare

 Lithium
battery

LED
CABINET
LIGHT

APPLICATION

Wide Applications: Ideal for cabinets, closets, basements, stairwells, indoor garages and so on.

FEATURES

01

3 CCT adjustable, warm white, natural white, and pure white can be switched easily.

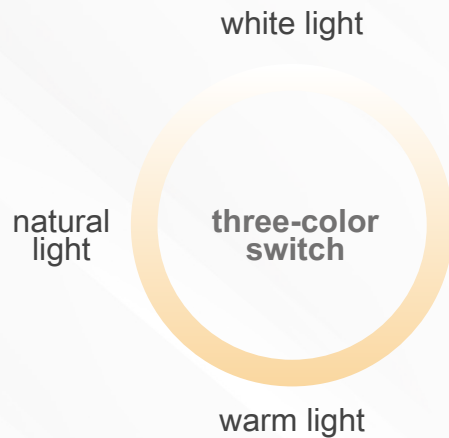

02

hand scanning version, brightness can be adjusted by hand hovering for two seconds with memory function



scanning hand one time to turn the light on and off
Adjust the CCT: Scanning hand two times (not exceeding 0.5S per interval),
delay 0.5S to switch color temperature.

FEATURES

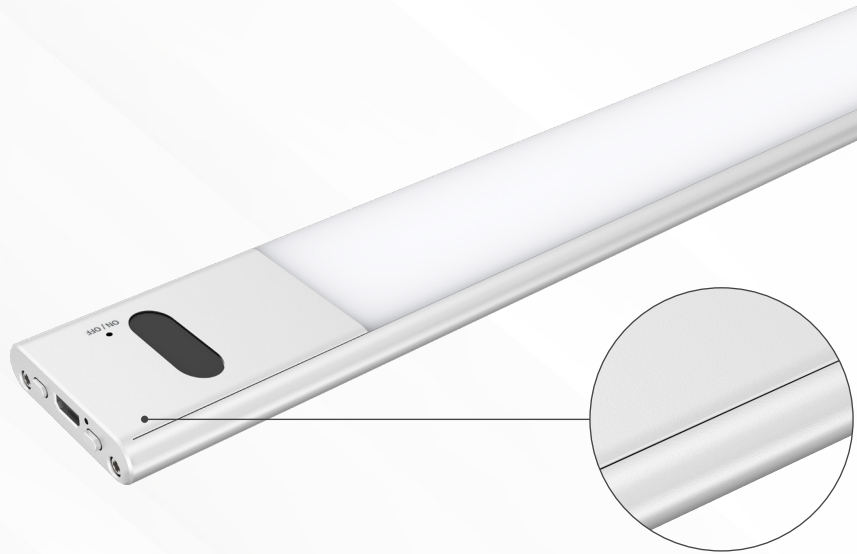

03

Made of high quality anodized aluminum, sturdy and sleek, much longer lifespan than other items on market.

04

- High quality PC milky white diffuser, uniform and soft light, protecting eyes
- Acrylic LGP, laser dotting technology , soft and uniform light, no yellow, long life span

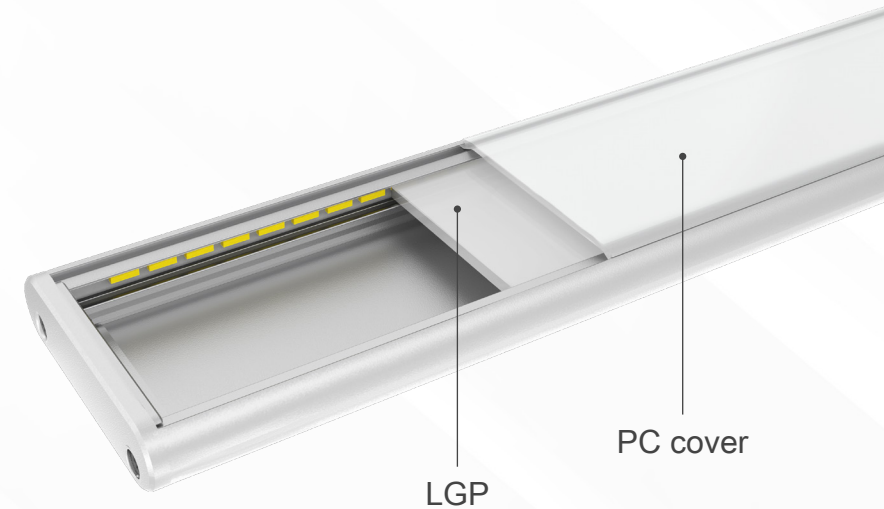

FEATURES

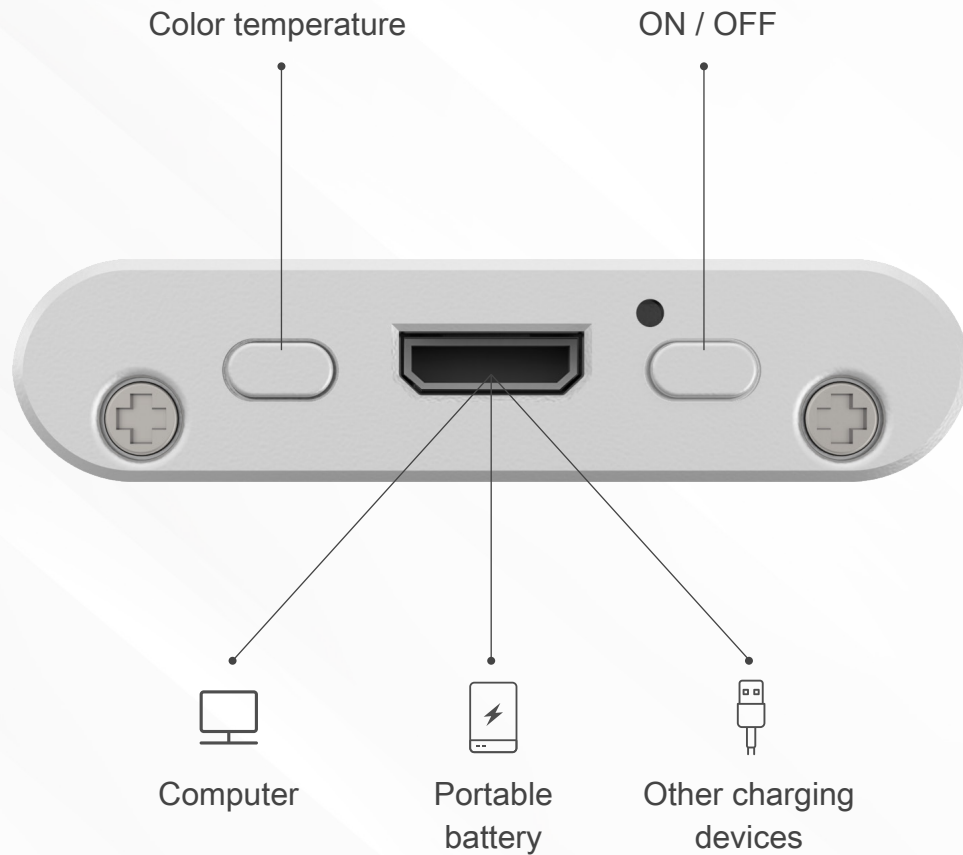

05

Color temperature and function buttons are made of mechanical button, good vibration and touch

06

Input DC5V, android USB charging port, computer, charge pal, etc.

FEATURES



07 

9.5MM ultra-thin thickness, equivalent to the thickness of a mobile phone

08 

No flickering, protecting eyes

09   

It can be used for two months after fully charged.

FUNCTION

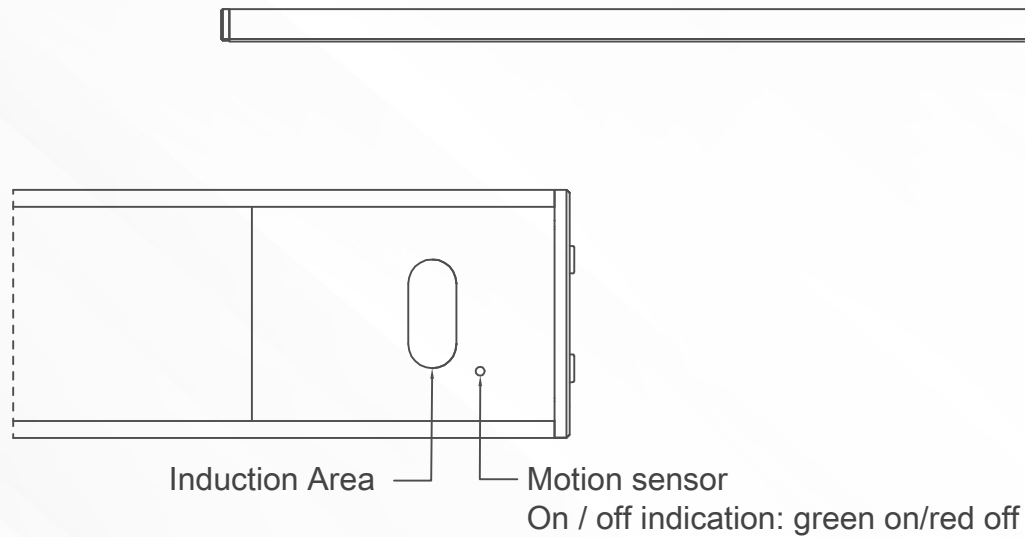

Detail section

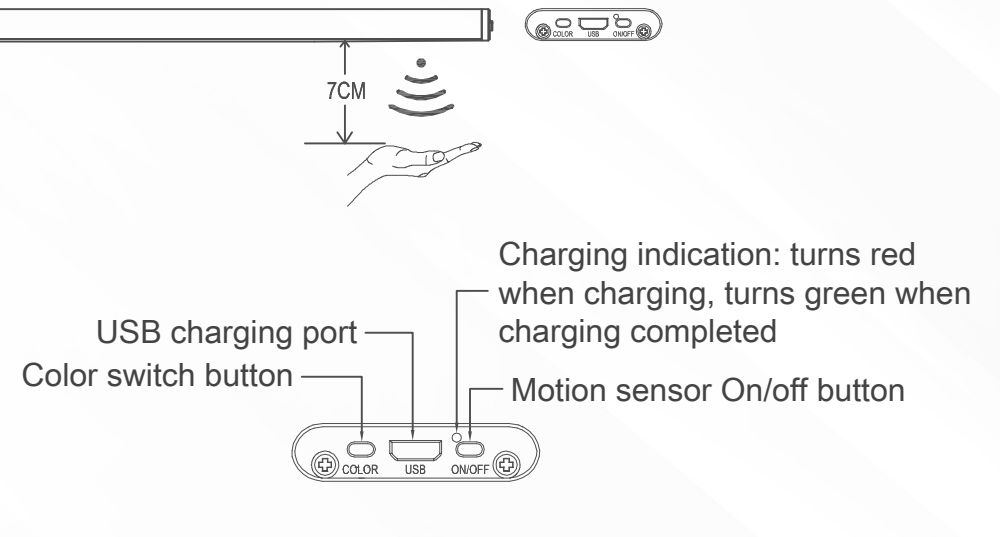

Detail section

Gesture sensing distance: 7CM

Operating mode: Wave once with one hand: on---off switch; Wave two times continuously: CCT switching;

Hand hovering in the air: brightness adjusting Induction Area

PARAMETER

Model	CL-002-240-HR-CCT-001	CL-002-400-HR-CCT-001	CL-002-600-HR-CCT-001
Lithium battery	750mA	1500mA	2200mA
Power	1W	2W	3W
Lumen	60lm	120lm	180lm
Length	240mm	400mm	600mm
Input voltage	5V		
Input current	1A		
CRI	≥80		
Induction delay	0s		
Color temperature button	warm white-natural white-pure white 3 levels adjustable		
Function button	ON/OFF		
Inductive distance	7CM		
Detection angle	0		
Operating temperature	-10°C ~ 40°C		

PACKAGING

Model	CL-002-240-HR-CCT-001	CL-002-400-HR-CCT-001	CL-002-600-HR-CCT-001
Net weight of single lamp	0.11kg	0.17kg	0.26kg
Gross weight per inner box	0.20kg	0.25kg	0.35kg
Inner box size	275*64*31MM	435*64*31MM	635*64*31MM
Carton size	445*416*345MM	568*286*345MM	650*350*280MM
Gross weight per carton	17.0kg	16.1kg	16.2kg
PCS	80pcs	60pcs	40pcs

DIMENSIONS (unit: mm)

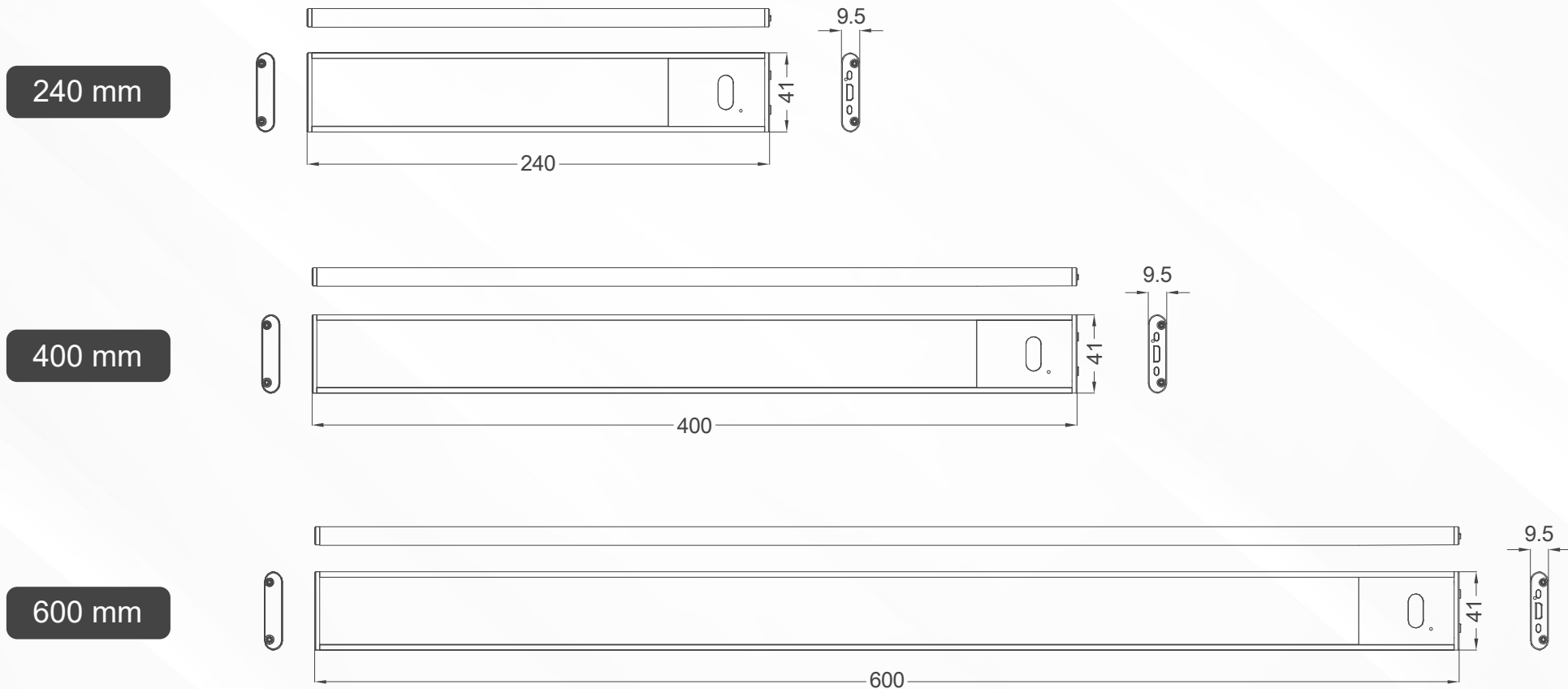

INSTALLATION DRAWING

01

Suitable for installation on rough surfaces
(such as rough board, gypsum ceiling, lime wall, etc.)

①



Attach the stator to the magnet position at the bottom of the lamp.

②

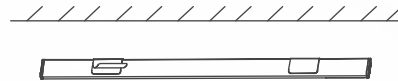

Tear off the release paper of 3M adhesive tape on the back of the stator.

③

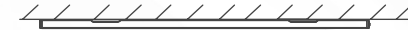

Plan an appropriate position, stick the lamp on the installation surface, and press it tightly.

④

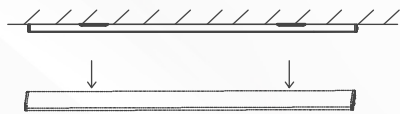

Press and hold the fixed iron plate, remove the lamp, and keep the fixed iron plate in a bonding state.

⑤

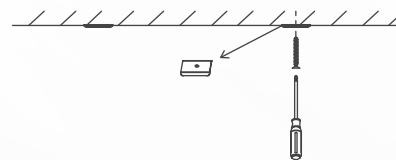

Use a tool to pass the screw through the hole in the middle of the stator, and fix the stator on the mounting surface.

⑥

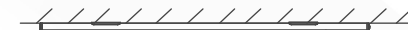

Align the magnet part of the lamp with the stator and absorb it on the mounting surface to complete the installation.

INSTALLATION DRAWING

02

Suitable for installation on smooth surfaces
(such as smooth wardrobe, table, tile, glass, etc.)

①

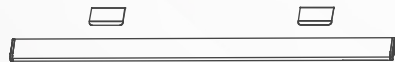

Attach the stator to the magnet position at the bottom of the lamp.

②



Tear off the release paper of 3M adhesive tape on the back of the stator.

③

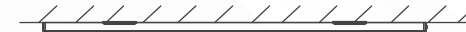

Plan an appropriate position, stick the lamp on the clean installation surface, and press it tightly.

INSTALLATION DRAWING

03

Using the magnetic back design, can stick on any iron product without any tools.

The installation surface is iron, such as iron bracket, iron cabinet, iron door frame and refrigerator, range hood, etc.

1

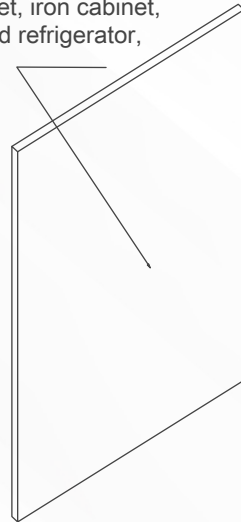

Ensure that the mounting surface is made of iron material.

2

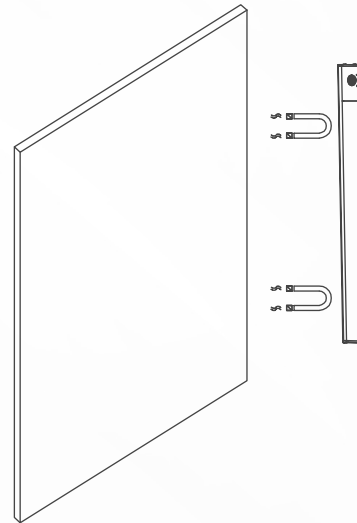

Through the magnet inside the lamp body, the lamp is directly attached to the surface of the iron material

3

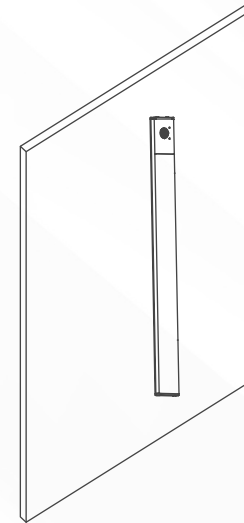

Installation is completed

NOTICE

- 1 The product is only suitable for indoor use, avoid long time work in humid environment;
- 2 Do not soak the product in water or other liquids;
- 3 Keep the inductive position of the product clean. If there is oil or water vapor, please clean it in time;
- 4 Do not install the product in a high temperature environment;
- 5 The charging voltage of the product is 5V, and the maximum current is 1A. Be careful not to use a charger exceeding the voltage and current to charge the lamp;
- 6 Do not use sharp objects or tools to pierce the inside of the lamp to prevent battery damage and cause accidents;
- 7 Do not disassemble and install the lamp and battery without permission;