

Tel: (86) 755 2760 8650
Email: info@signcomplex.com
Web: www.signcomplex.com



Signcomplex
light and smart



COMMERCIAL LIGHTING



▲ China Factory (100,000m² / 600 employees)

About Signcomplex

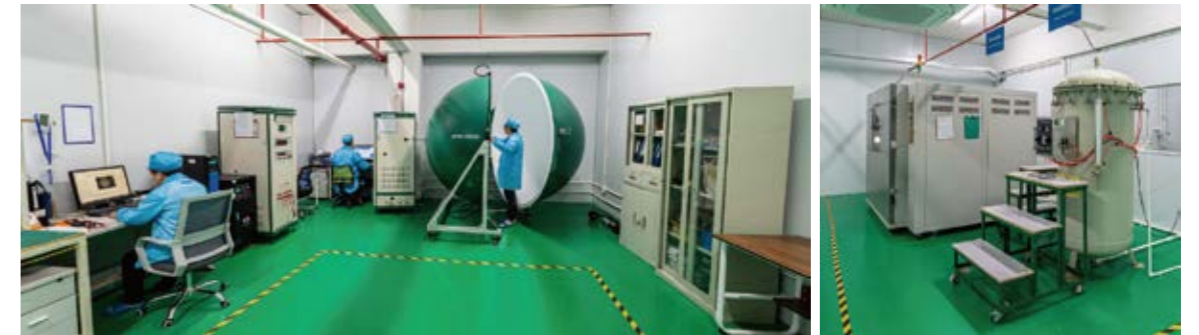

▲ China Laboratory



	Founded in 2006		Factory area 110,000m ² (China 100,000m ² +Thailand 1,000m ²)
	900+ employees		Main products Commercial lighting / Strip lighting Industrial lighting
	Certified systems ISO9001:2015 quality system ISO14001 environmental system BSCI Social Responsibility System		Product certification CE/RoHS/UL/UKCA/ETL/FCC/ENEC/JA8/ENERGY STAR/DLC/CB, etc.
	Market share North America 45% / Europe 40% / other 15%		National high-tech enterprise
	300+ patents		Customized service



▲ Thailand Office



▲ Thailand Factory (10,000m² / 150 employees)

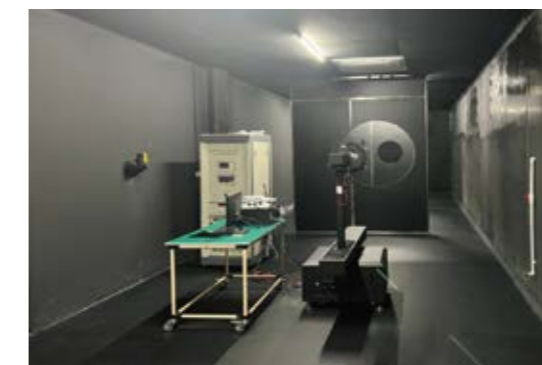

▲ Thailand Laboratory

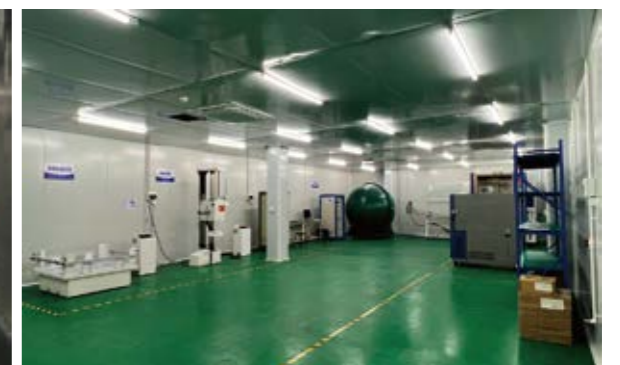















▲ Thailand Laboratory

COMMERCIAL LIGHTING

CONTENT



	Integrated Design 01 Down Light (DL107K Series)
	Integrated Design 03 Smart Down Light (DL107R Series)
	Integrated Design 05 PIR Sensor Down Light (DL107RS Series)
	Integrated Design 07 Emergency Down Light (DL107E Series)
	Modular Design 09 Commercial Down Light (DL109 Series)
	Commercial Down Light 11 Economy Series (DL211 Series)
	Wafer Slim Down Light 13 Economy Series
	Wafer Slim Down Light 15 Premium Series
	Slim Wafer Night Light 17 TDC Series
	Flush Mount Down Light 19 Color Adjustable Series
	HAT Down Light 21 DL207P Series)
	Wafer Slim Down Light 23 Fire-Rated Series
	Fire-Rated Down Light 25 DL106 Series
	Magnetic Seamless Linkable 27 8860 Series Linear Light
	Linear Strip Light 29 ST01 Series



Integrated Design Down Light

(DL107K Series)



Parameters

Size	Power	Light efficiency @4000K	Luminous flux @4000K	CCT	Input voltage	Light source CRI
4inch	6-8-10-12-16W	130LPW	770-1040-1300-1500-1850LM	2700K-3000K-	AC 120-277V/347V	2835
6inch	12-16-22-26-30W	130LPW	1600-2200-3000-3500-4000LM	3500K-4000K- 5000K	(0-10V dimming), AC 120-347V	CRI>90
8inch	22-26-30-35-40W	130LPW	3080-3614-4110-4725-5280LM	(5CCT tunable)	(0-10V/Triac/ELV)	
10inch	26-30-35-40-45W	130LPW	3425-4020-4620-5280-5760LM			

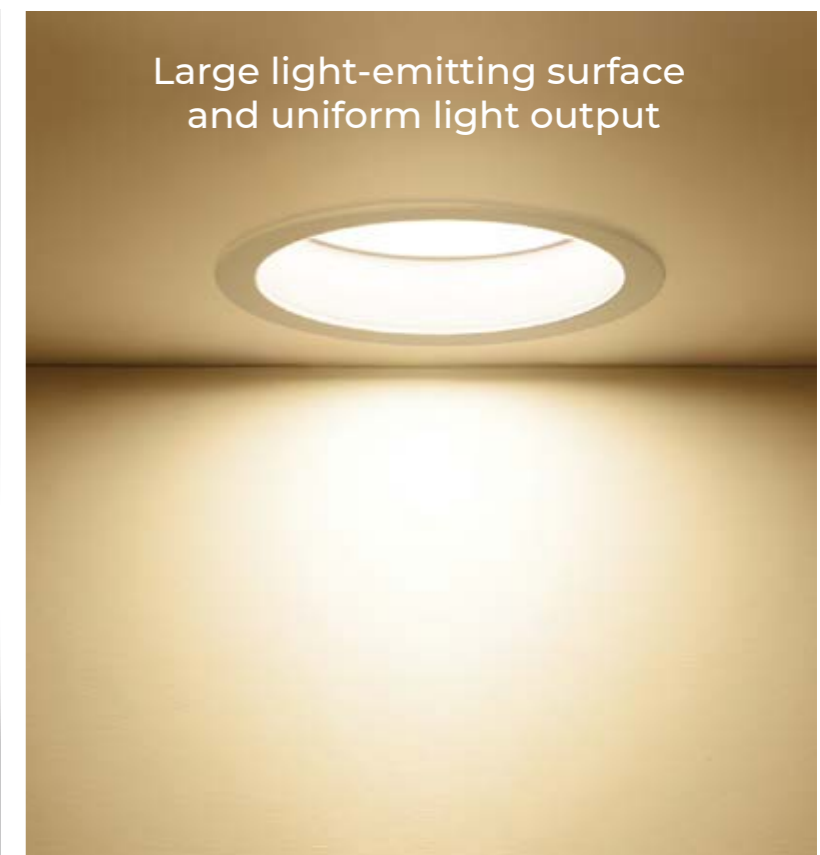
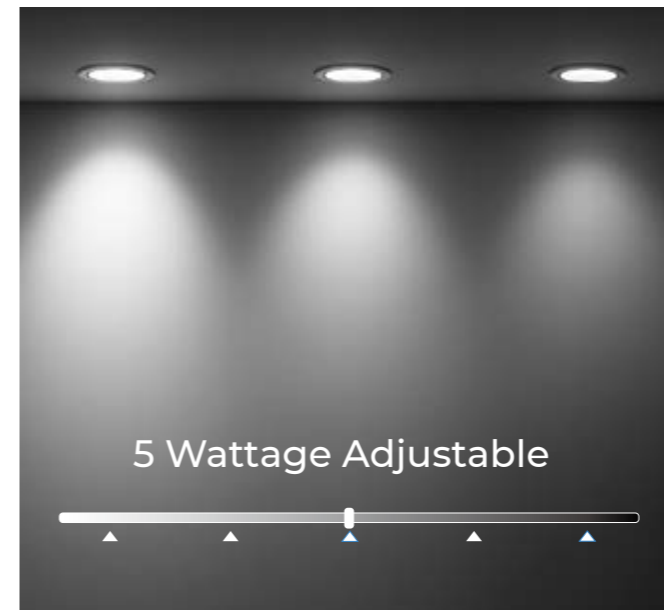

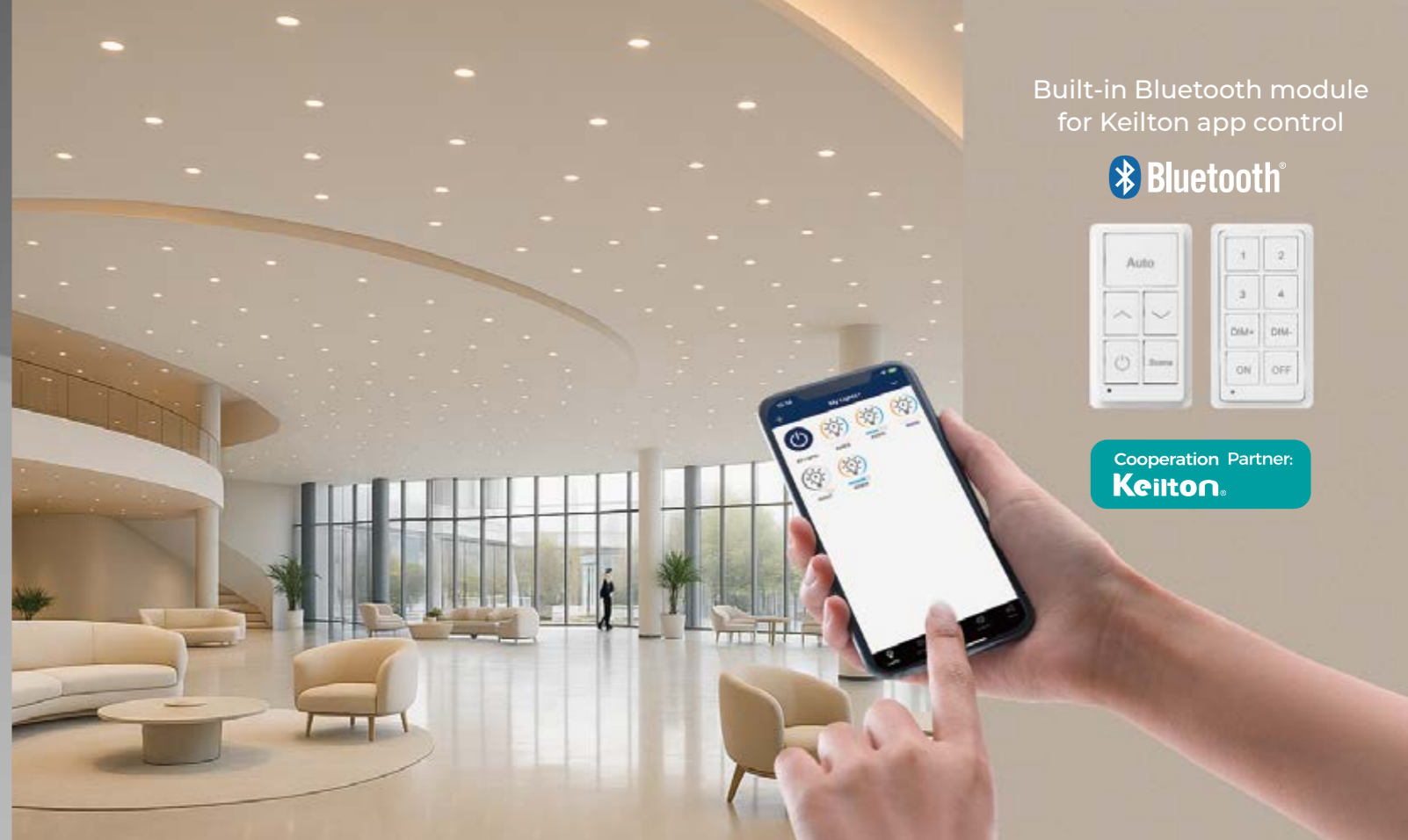

Built-in Bluetooth module for Keilton app control



Cooperation Partner: **Keilton**

120 LPW

Integrated Design Smart Down Light

(DL107R Series)



Parameters

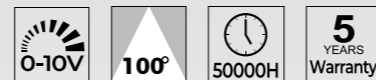

Size	Power	Light efficiency @4000K	Luminous flux @4000K	CCT	Input voltage	Light source CRI
6inch	30W	120LPW	3750LM	2700K-3000K-3500K-4000K-5000K(5CCT tunable)	100-277/347V	2835 CRI>90
8inch	40W	120LPW	4750LM			

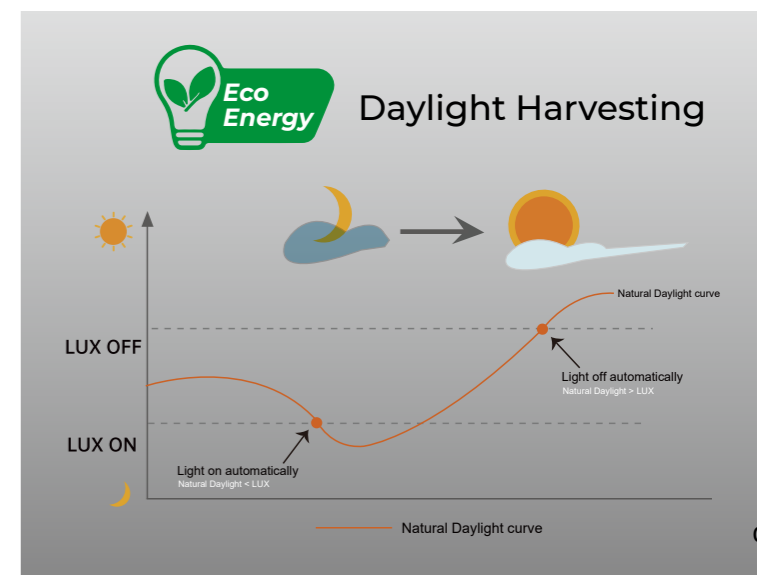
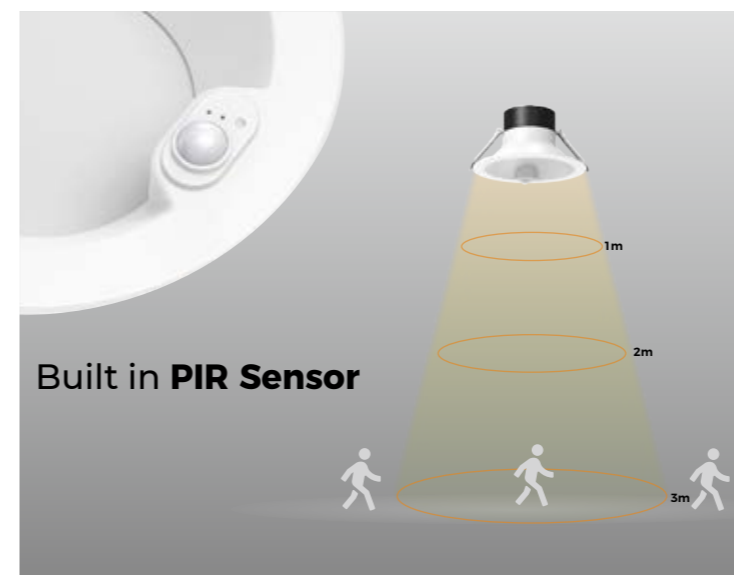

Integrated Design PIR Sensor Down Light

(DL107RS Series)



Parameters

Size	Power	Light efficiency @4000K	Luminous flux @4000K	CCT	Input voltage	Light source CRI
6inch	12-16-22-26-30W	130LPW	1600-2200-3000-3500-4000LM	2700K-3000K- 3500K-4000K- 5000K	AC 120-277V/347V (0-10V dimming), AC 120-347V	2835 CRI>90
8inch	22-26-30-35-40W	130LPW	3080-3614-4110-4725-5280LM	(5CCT tunable)	(0-10V/Triac/ELV)	

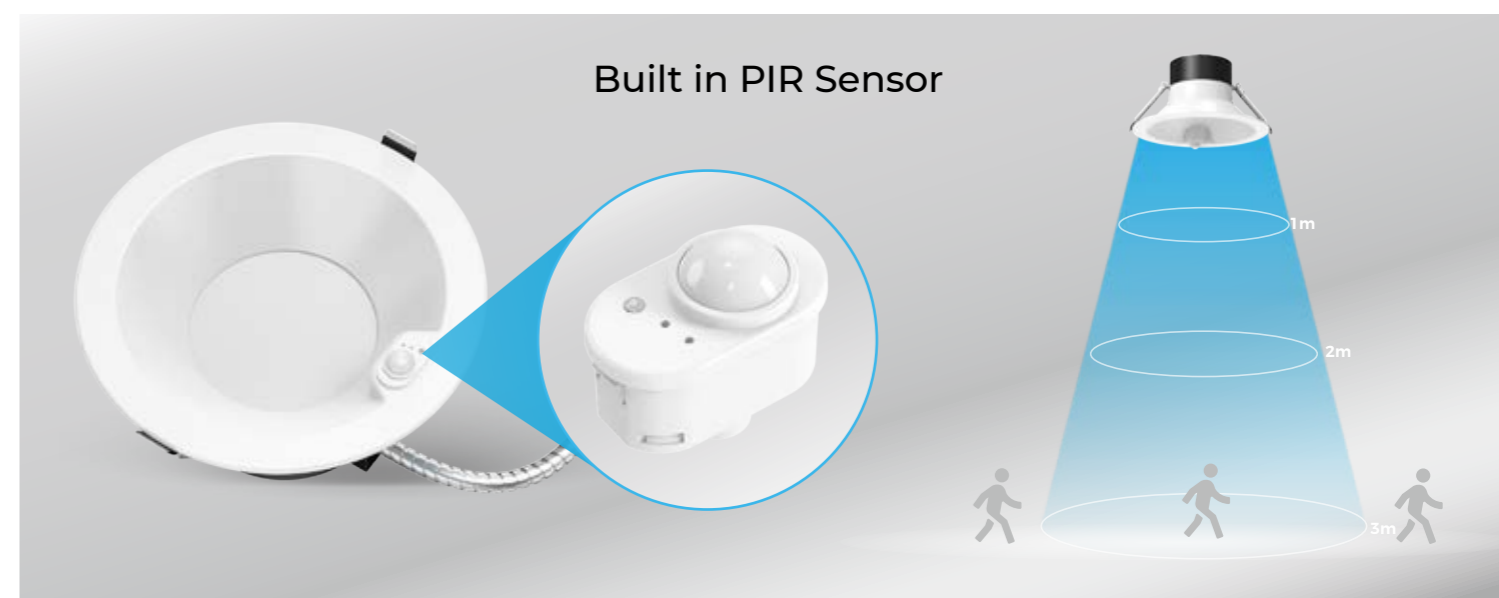
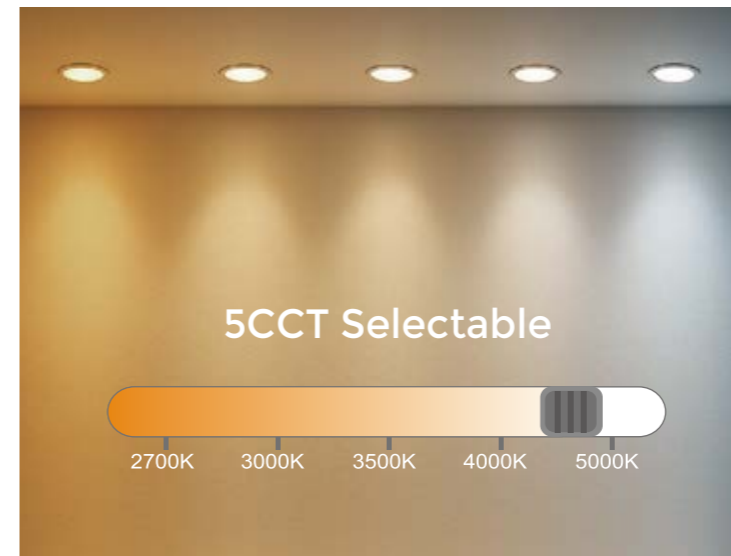



Integrated Design Emergency Down Light

(DL107E Series)



Parameters



Size	Power	Light efficiency @4000K	Luminous flux @4000K	Emergency power	CCT	Input voltage	Light source CRI
6inch	30W	110LPW	3300LM	8W/15W/25W	2700K-3000K- 3500K-4000K-	100-277/ 347V	2835 CRI>90
8inch	40W	110LPW	4400LM		5000K(5CCT tunable)		



Luminous indicator switch, built-in lithium battery with overcharge, over-discharge, and short-circuit protection, supports 500 charge-discharge cycles.



500 cycles



Emergency time

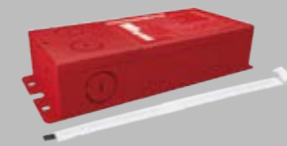

Emergency drive

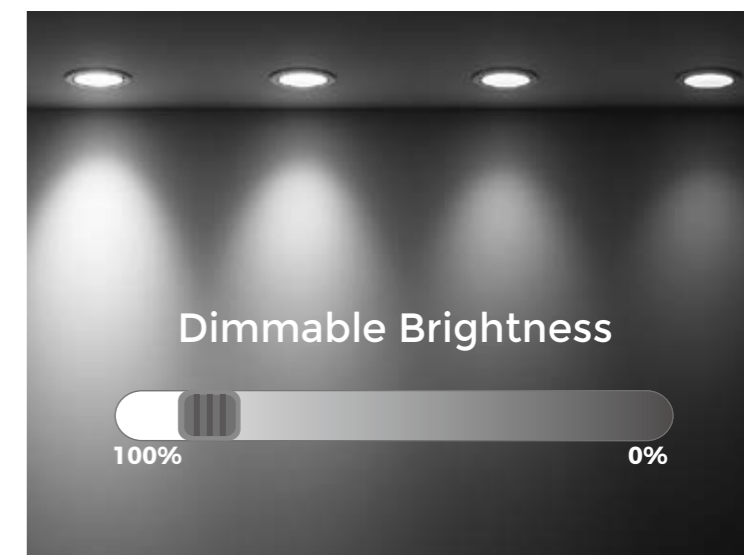
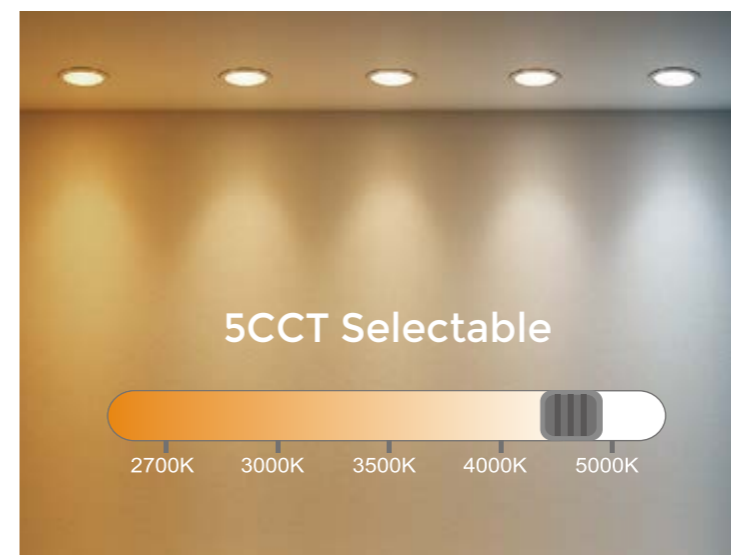

Modular Design Commercial Down Light

(DL109 Series)



Parameters



Module	Power	Light efficiency @4000K	Luminous flux @4000K	CCT	Input voltage	Light source CRI
M110	18-24-30W	85LPW	2550LM	2700K-3000K- 3500K-4000K- 5000K(5CCT tunable)	AC 120-277V/347V (0-10V dimming), AC 120-347V (0-10V/Triac/ELV)	COB CRI>90
M140	30-40-50W	85LPW	4500LM	2700K-3000K- 3500K-4000K- 5000K(5CCT tunable)	AC 120-277V/347V (0-10V dimming)	COB CRI>90

Lens angle adjustable
from **24° to 60°**

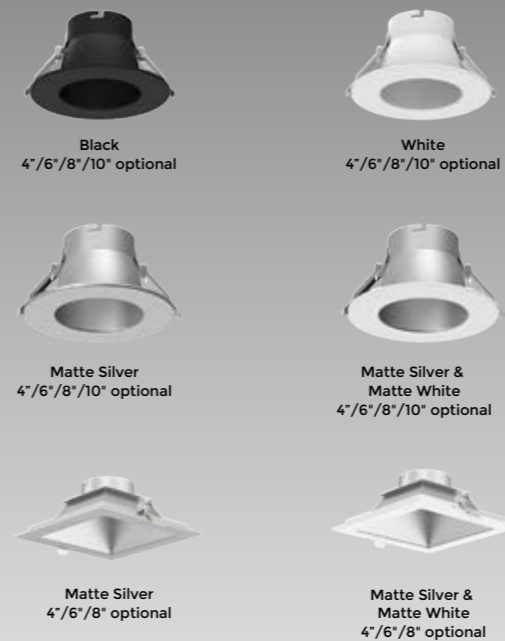

UGR<19, anti-glare
COB design, no light spot



Replaceable reflector

5CCT Selectable+
Wattage Adjustable

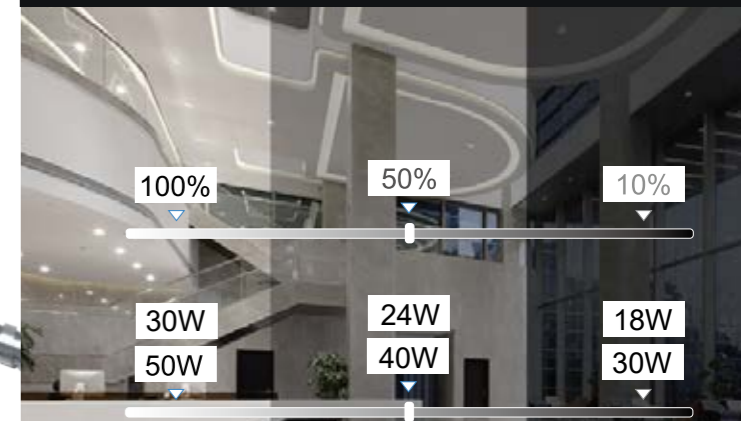
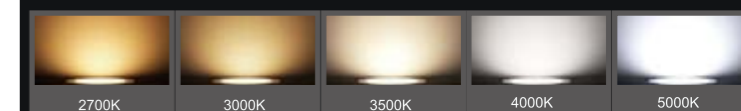
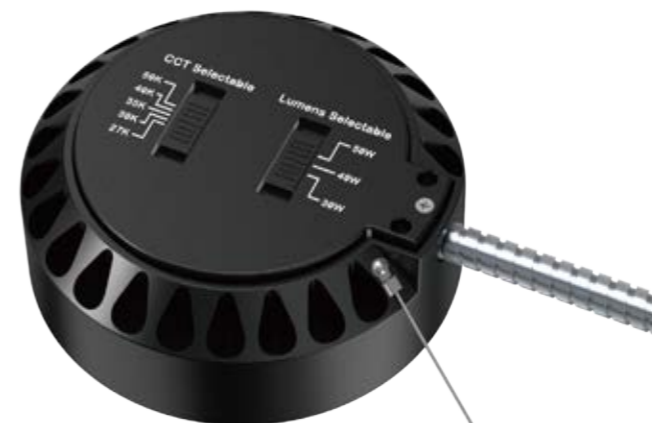

Commercial Down Light

DL211 Economy Series



Parameters



Size	Power	Light efficiency @4000K	Luminous flux @4000K	CCT	Input voltage	Light source CRI
4inch	7-11-15W	90LPW	700-1050-1350LM			
6inch	10-14-18W	90LPW	950-1350-1650LM	2700K-3000K- 3500K-4000K-	AC 120V(Triac), AC 120-277V/347V (0-10V dimming),	2835 CRI>90
8inch	18-24-30W	90LPW	1800-2250-2650LM	5000K(5CCT tunable)	AC 120-347V (0-10V/Triac/ELV)	
10inch	22-30-38W	90LPW	2100-2700-3350LM			

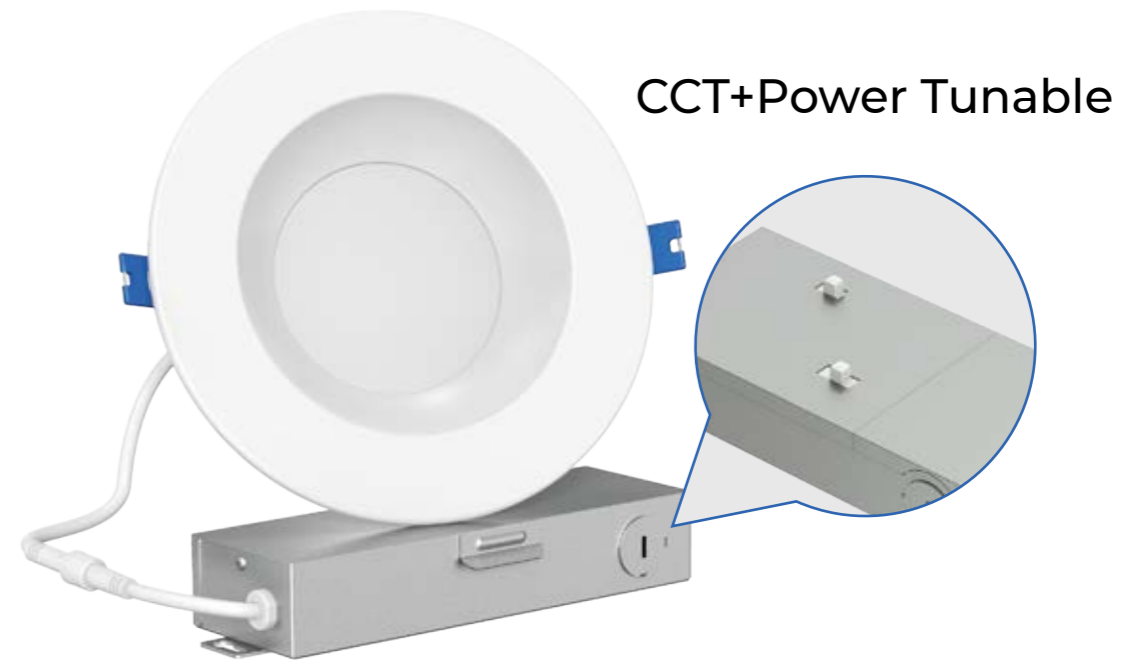

CCT+Power Tunable

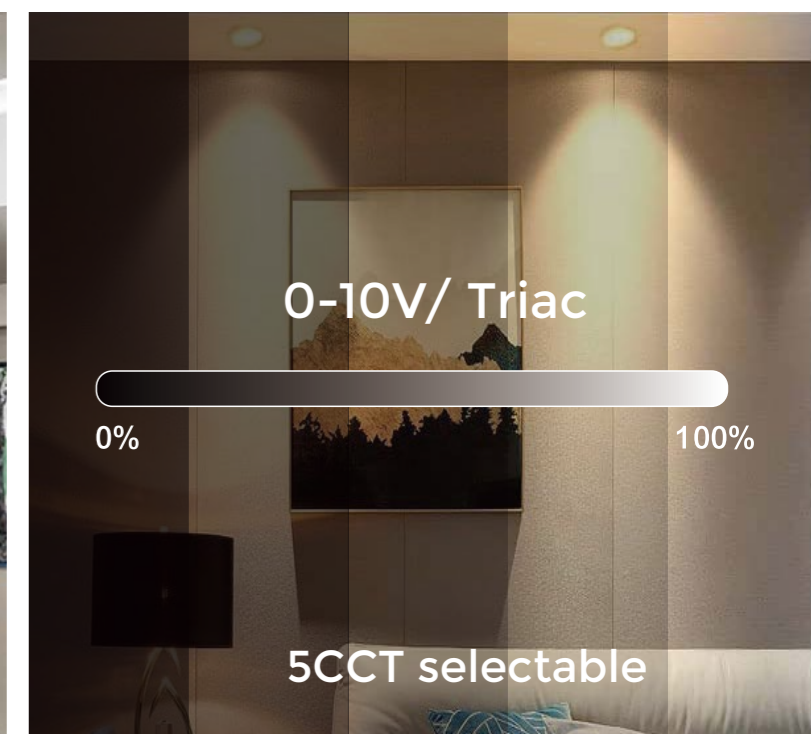

Wafer Slim Down Light

(Economy Series)



Parameters

Size	Power	Light efficiency @4000K	Luminous flux @4000K	CCT	Input voltage	Light source CRI
3inch	7W	82LPW	574LM			
4inch	9W	82LPW	740LM	2700K/3000K/ 3500K/		
6inch	12W	85LPW	1050LM	4000K/5000K		
8inch	18W	85LPW	1530LM		AC 120V(Triac), AC 120-277V/347V (0-10V dimming)	2835 CRI>90
3inch*	7W	>82LPW	585LM			
4inch*	9W	>82LPW	770LM	2700K-3000K- 3500K-4000K-		
6inch*	12W	>82LPW	1100LM	5000K(5CCT tunable)		
8inch*	18W	>82LPW	1530LM			

*0-10V dimming: just replace the power supply with triac version, same lamp body.

0-10V/ Triac Dimming



5CCT Selectable

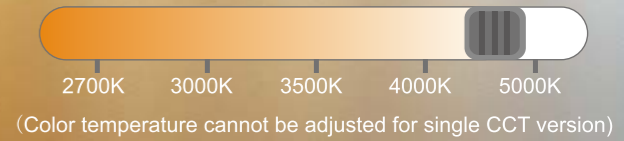

The trim for replacement

Quick change, safe and reliable

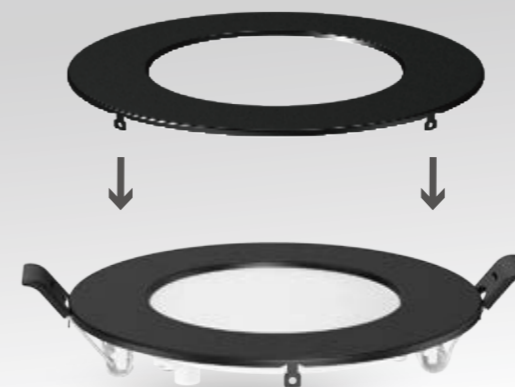

Black

Trim options



Brown



White



Golden

Installation accessories

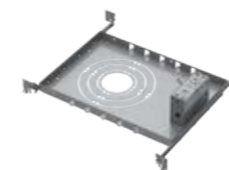

3"/4"/6"/8" Integrated Installation kit



3"/4"/6"/8" Integrated Installation kit



Emergency power supply

Wafer Slim Down Light

(Premium Series)



Parameters



Size	Power	Light efficiency @4000K	Luminous flux @4000K	CCT	Input voltage	Light source CRI
4inch	9W	>82LPW	820LM			
6inch	12W	>82LPW	1060LM	2700K-3000K-3500K-4000K-	AC 120V(Triac), AC 120-277V/347V (0-10V dimming)	2835 CRI>90
4inch*	5-7-9W	>82LPW	500-700-820LM	5000K(5CCT tunable)		
6inch*	7-9-12W	>82LPW	620-820-1060LM			

Types Available

5CCT Selectable+ 3Wattage Adjustable | 5CCT Selectable | 3Wattage Adjustable

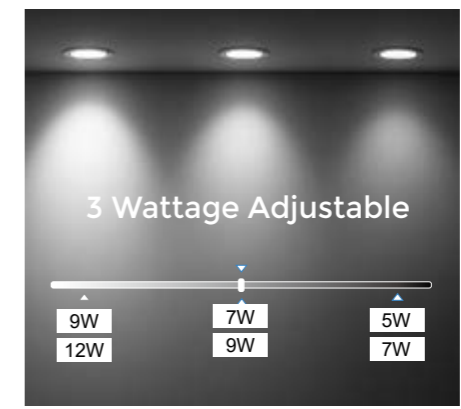

Slim Wafer Night Light

(TDC Series)

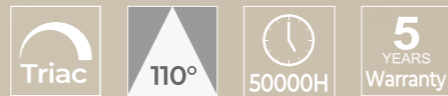

Size	Power	Light efficiency @4000K	Luminous flux @4000K	CCT	Input voltage	Light source CRI
4inch	9W+3W(night light)	>85LPW	630LM	2700K-3000K- 3500K-4000K-5000K/ 2200K(night light)	AC 120V	2835&5050 CRI>90
6inch	12W+3W(night light)	>85LPW	900LM			
4inch*	9W+3W(night light)	>85LPW	550LM	2700K-6000K/ RGBIC(night light)	AC 120V	2835&5050 CRI>90
6inch*	12W+3W(night light)	>85LPW	850LM			

5CCT Dip Switch Version

2700K 3000K 3500K 4000K 5000K

5CCT adjustable inner luminous surface, 2200K with night light

RGB Magic Color Version

16 Million Colors

Side auxiliary light: RGB color-changing
Front main light: Adjustable warm white

Dual-ring smart luminaire with premium aluminum housing

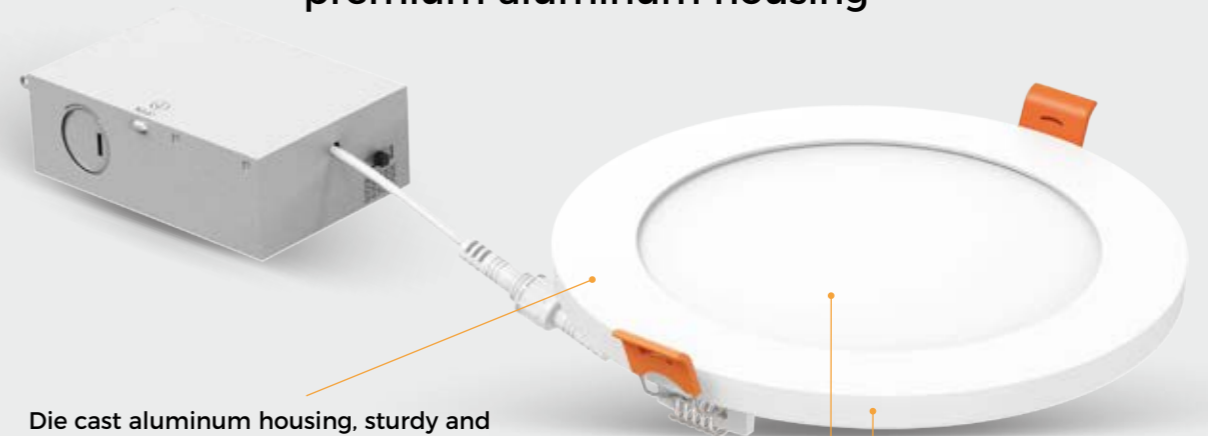

Die cast aluminum housing, sturdy and durable, good texture and thermal conductivity, corrosion resistance.

Dual-ring luminous design—inner and outer rings can be lit separately or together.

Smart strain-relief design for secure & safe installation



Strain-relief connector with screw cap for stable connection.

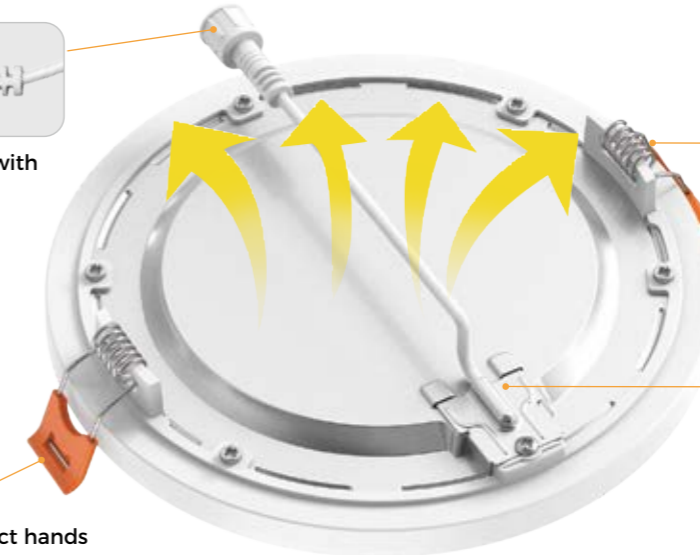

High quality circlip, high hardness, good elasticity and durable.

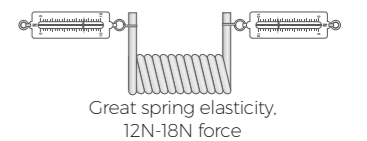

Strain relief design at outlet.

Plastic end sleeves protect hands and lamp body during installation.

Flush Mount Down Light

(Color Adjustable Series)



Twist-and-lock design for easy 3-step installation

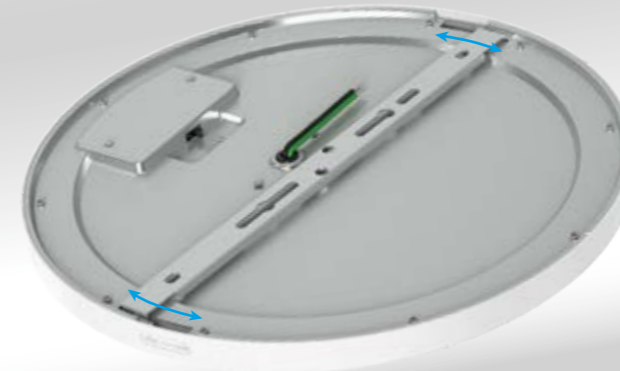

Super slim lamp body

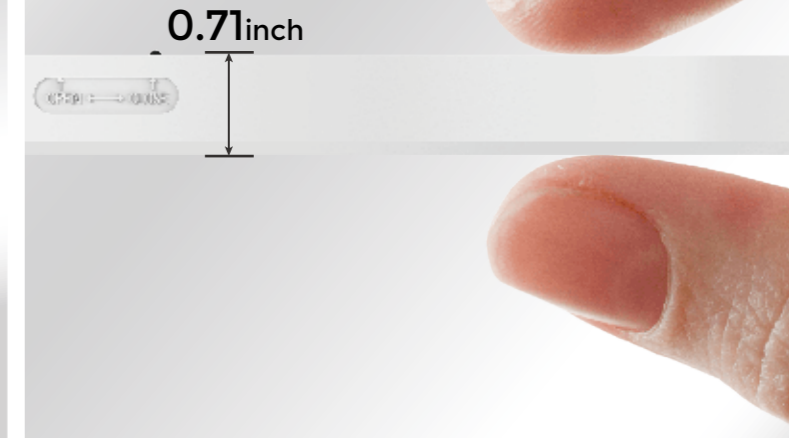

Square flush mount options

PS light guide plate, UV-resistant and anti-yellowing.

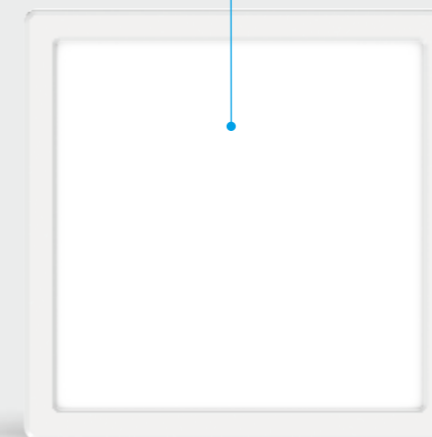

5CCT Dip switch

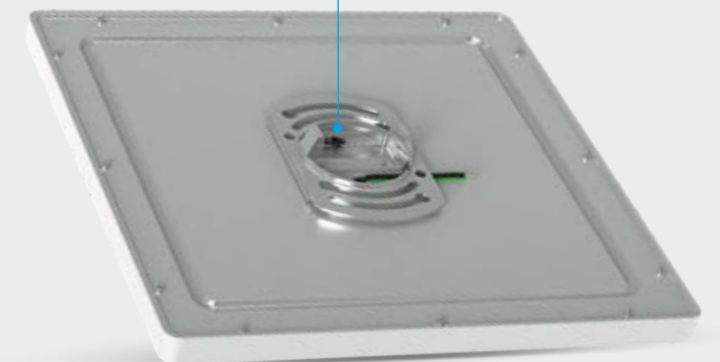

Parameters



Size	Power	Light efficiency @4000K	Luminous flux @4000K	CCT	Input voltage	Light source CRI
5inch	9W	85LPW	765LM			
7inch	12W	82LPW	1020LM	2700K-3000K- 3500K-4000K-	120V AC	2835 CRI>90
9inch	18W	82LPW	1530LM	5000K(5CCT tunable)		
11inch*	22W	82LPW	1870LM			

*11 inch no energy star certification

HAT Down Light

(DL207P Series)



5CCT Selectable



Dimmable Brightness

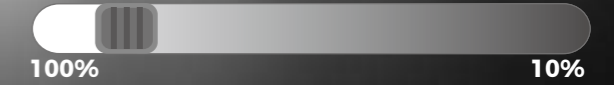

Nano-thermal plastic, lightweight with great heat dissipation.

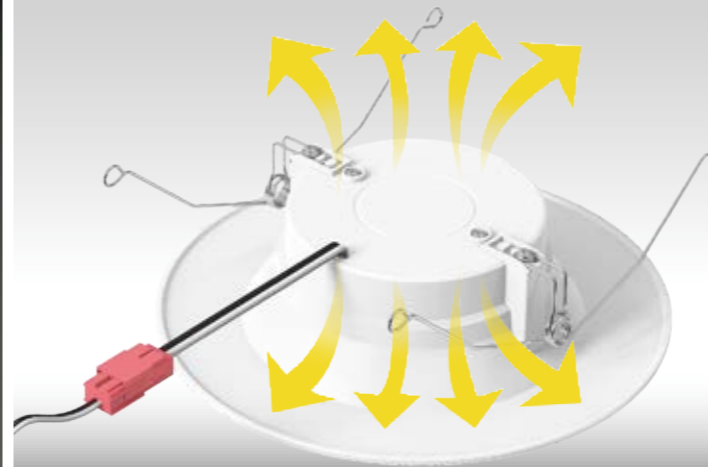

Uniform light, 90 high CRI



Unique appearance, beautiful design and gorgeous.



Side switch design for easy color temperature adjustment.

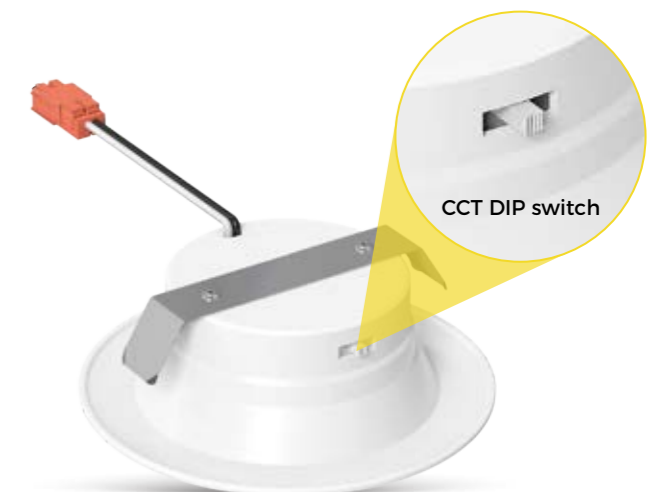

Optional with 2200K night light

Parameters



Size	Power	Light efficiency @4000K	Luminous flux @4000K	CCT	Input voltage	Light source CRI
4inch	9W	85LPW	760LM	2700K-3000K-3500K-4000K-	120V AC	2835 CRI>90
6inch	14W	85LPW	1190LM	5000K(5CCT tunable)		

Wafer Slim Down Light

(Fire-Rated Series)

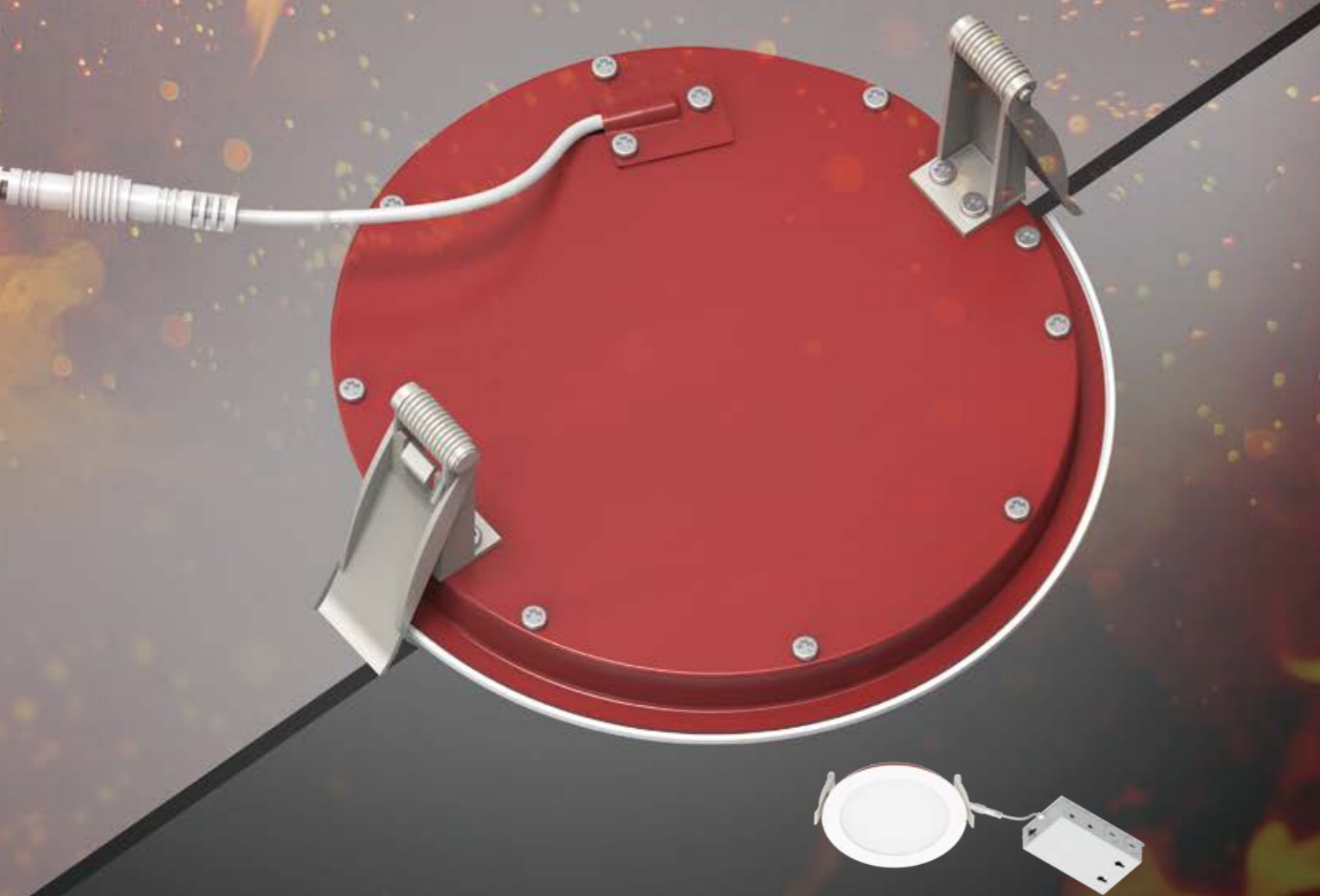

Parameters

Size	Power	Light efficiency @4000K	Luminous flux @4000K	CCT	Input voltage	Light source CRI
3inch	6W	85LPW	500LM	2700K-3000K-3500K-4000K-5000K(5CCT tunable)	100-130V AC	2835 CRI>90
4inch	9W	85LPW	770LM			
6inch	12W	92LPW	1100LM			
8inch	18W	92LPW	1530LM			



0.8mm Thick Fireproof Iron Back Cover

Great spring elasticity 50-70N force

Strain relief plate for easy installation & strong pull resistance

5CCT Adjustable (2700K-3000K-3500K-4000K-5000K)

High efficiency up to 100LPW

Compatible with TRIAC dimmers (10%-100%)

Fire-Rated Down Light

(DL106 Series)



2 HOUR
FIRE RATED



Parameters

Size	Power	Light efficiency @4000K	Luminous flux @4000K	CCT	Input voltage	Light source CRI
4inch	7-9-12W	125LPW	1000-1200-1600LM			
6inch	10-14-18W	125LPW	1250-1800-2250LM	2700K-3000K- 3500K-4000K-	100-277/ 347V AC	2835 CRI>90
8inch	15-20-25W	125LPW	2000-2700-3300LM	5000K(5CCT tunable)		
10inch	18-24-30W	125LPW	2400-3000-3750LM			



5CCT Selectable

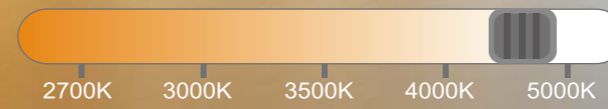

Dimmable Brightness

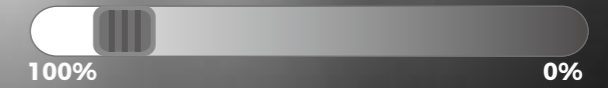

ANTI-GLARE FIREPROOF DOWNLIGHT

Cut-Off Angle

30°

Shielding Angle

30°



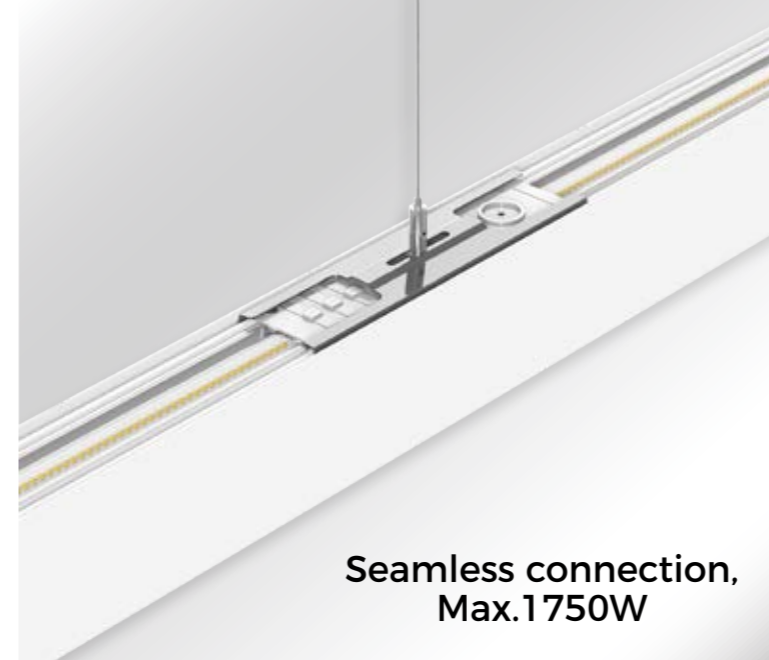
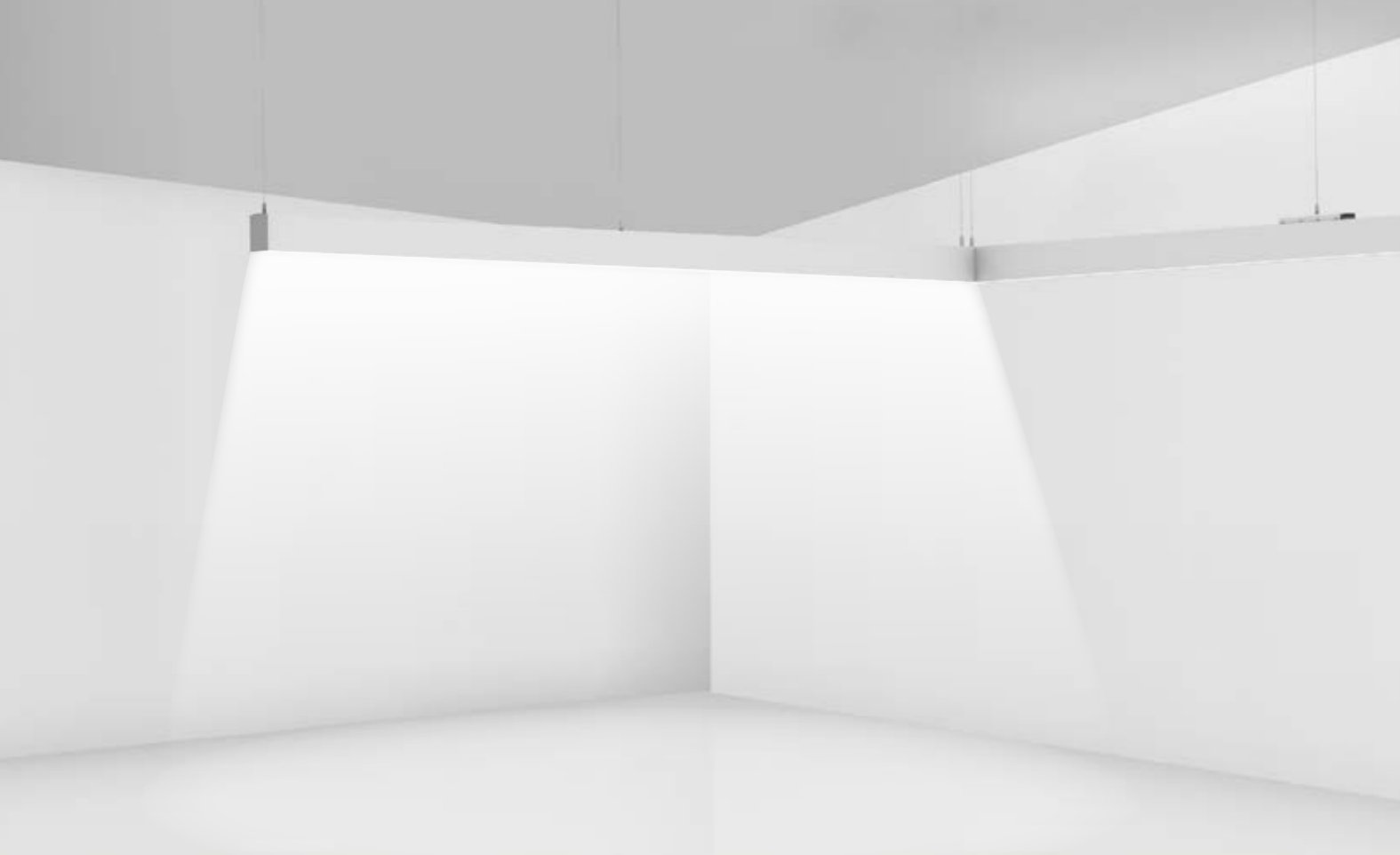

Seamless connection,
Max.1750W



Easy to link,
without tools

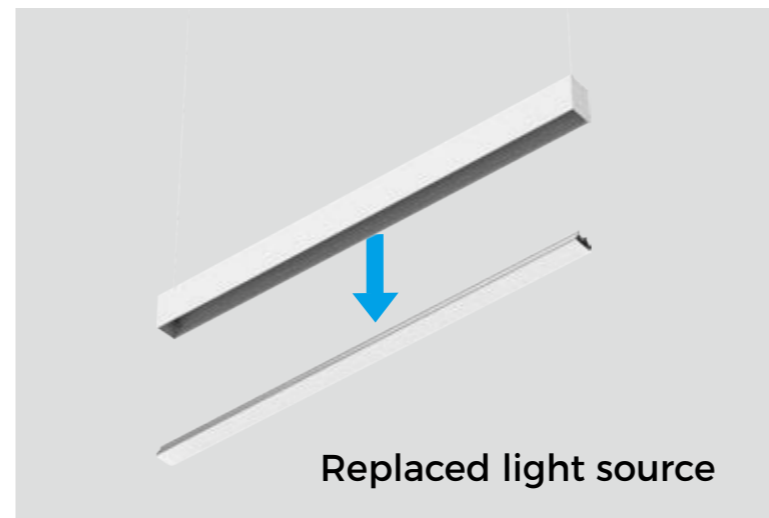

Replaced light source

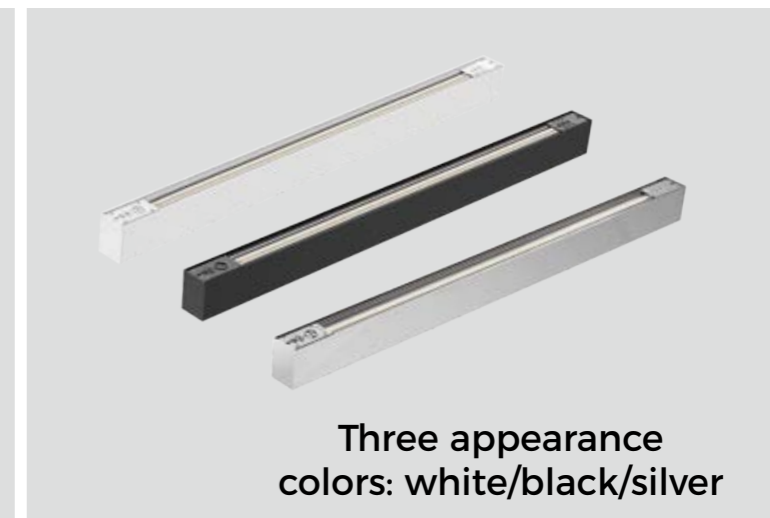

Three appearance
colors: white/black/silver

Magnetic Seamless Linkable

(8860 Series Linear Light)



Parameters



Size	Power	Light efficiency @4000K	Luminous flux @4000K	CCT	Input voltage	Light source CRI
2FT	12/15/25W	115LPW	1725-2875LM	3000K-4000K- 5000K(3CCT tunable)	100-277/ 347V AC	2835 CRI>80
4FT	30/40/50W	115LPW	3450-5750LM			
8FT	60/80/100W	115LPW	6900-11500LM			
2FT	12/15/25W	130LPW	1950-3250LM	3000K-4000K- 5000K(3CCT tunable)	100-277/ 347V AC	2835 CRI>80
4FT	30/40/50W	130LPW	3900-6500LM			
8FT	60/80/100W	130LPW	7800-13000LM			

Installation accessories

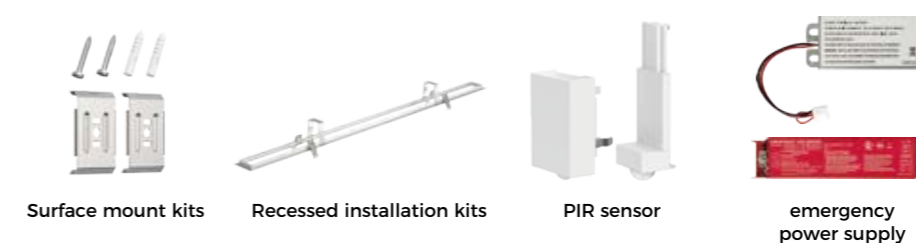
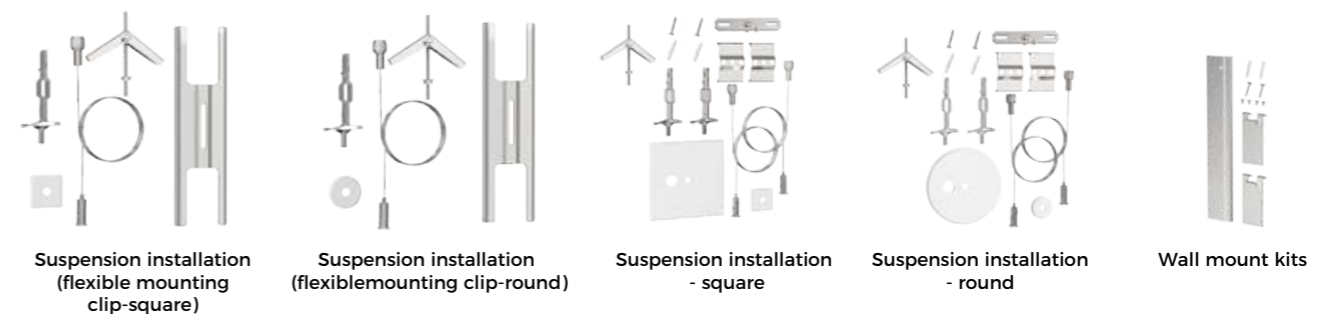

Linear Strip Light

(ST01 Series)



Parameters



Size	Power	Light efficiency @4000K	Luminous flux @4000K	CCT	Input voltage	Light source CRI
2FT	12/15/20W	130LPW	1560-1950-2600LM			
4FT	25/30/40W	130LPW	3250-3900-5200LM	3500K-4000K- 5000K(3CCT tunable)	120-277/ 347V AC	2835 CRI>80
8FT	50/60/70W	130LPW	6500-7800-9100LM			
2FT	10-15-17.5-20-25W	130LPW	1300-1950-2275-2600-3250LM	3500K-4000K- 4500K-5000K- 5700K(5CCT tunable)	120-277/ 347V AC	2835 CRI>80
4FT	12-20-30-35-40W	130LPW	1560-2600-3900-4550-5200LM			
8FT	24-30-50-64-80W	130LPW	3120-3900-6500-8320-1040LM			

Quick 10-second single-person connection saves time

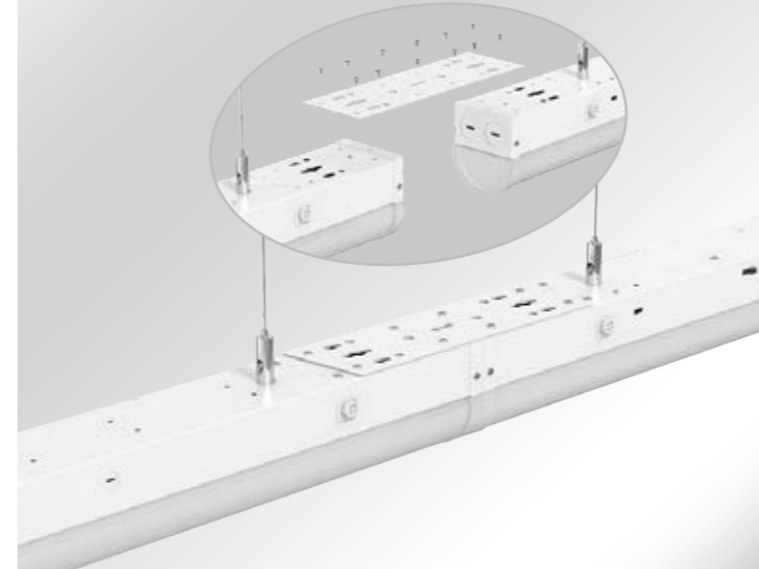

5CCT Selectable

3500K 4000K 4500K 5000K 5700K

Extruded color steel bracket, fire-resistant PC material cover



Adjustable power and CCT via dip switch

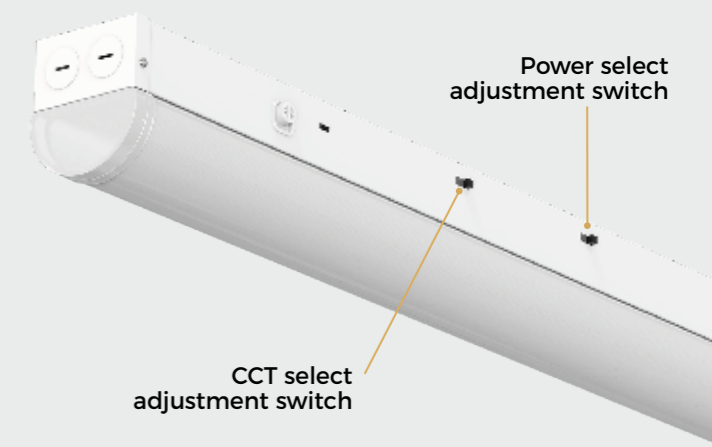

Installation accessories



Ceiling(2FT/4FT)



Ceiling(8FT)



Suspending installation



Suspension splicing



Ceiling splicing(2FT/4FT)



Ceiling splicing(8FT)



Hook



Microwave induction



Emergency power