

4-in-1 DMX512 Digital NeonFlex



Available colors



Features

- 5050 4-in-1 LED, can have RGB and White both;
- CRI80 or CRI90 available for White Color;
- 24VDC, 17W/M,controllable every 7 LEDs(100mm);
- Adopt DMX512(1990)IC, with high reliability and practicability;
- Abundant color mix pattern, with PWM256 gray level control, more than 16 million;
- Silicon-tube sleeved, production process is simple and stable, bending resistance reliable, waterproof grade up to IP65;
- Elegant appearance; Side View Dot-free illumination;
- Match all kinds of DMX512 controller sold in market, do not need to customize special controller;
- CE, RoHS compliant, 5-year warranty

Technical parameters

Model	Wave Length & CCT Range		Luminous Flux (lm/M)	CRI	PCB Width (mm)	LED Qty. (PCS/M)	Rated Watt (W/M)	DC Voltage (V)	Max. Length (M)	IP
SC-DMX512-RGBW-24V SC-DMX512-RGBNW-24V SC-DMX512-RGBWW-24V	R	620-630nm	/	/	12	70	17	24	5	65
	G	515-530nm								
	B	460-470nm								
	WW	2800-3200K	118	80 (CRI90 available)						
	NW	3800-4500K	125							
	W	6000-6500K	135							

Dimensions (unit: mm/inch)

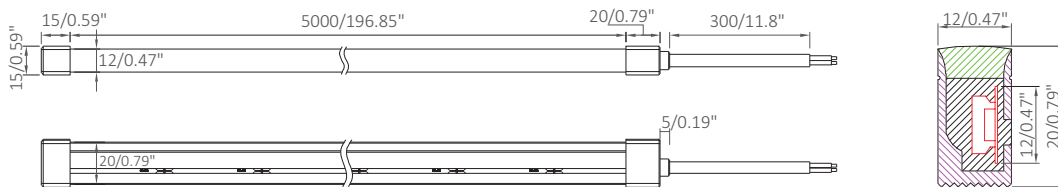

Accessories

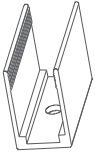
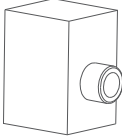
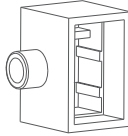
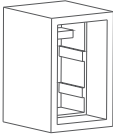
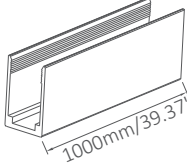
Name	Mounting Clip	End cap with hole		End cap without hole	Mounting Channel
Picture					
Quantity	20pcs per reel	optional	optional	optional	optional

Installation diagram

1. Pull a parallel string on which the LED strip will be installed, as figure 1

surface which strip will be installed on (inverse, vertical, horizontal or 90° vertically)

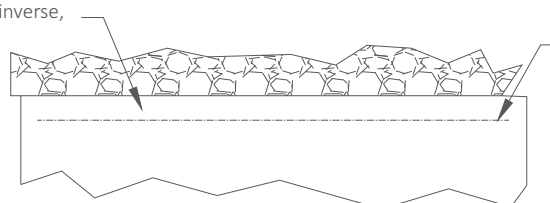

Base a line which will be used for installing the strip

2. Fix the clip on the base line, and the distance depends on practical situation, as figure 2

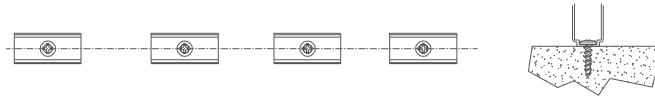

3. After the clip is fixed, insert the LED strip into the slot with luminous surface closing to the thumb, as figure 3

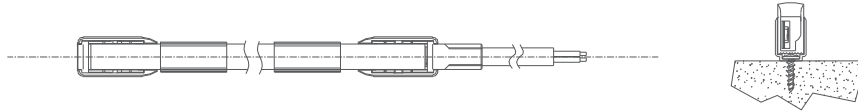

4. Connect power wire and finish the installation, as figure 4

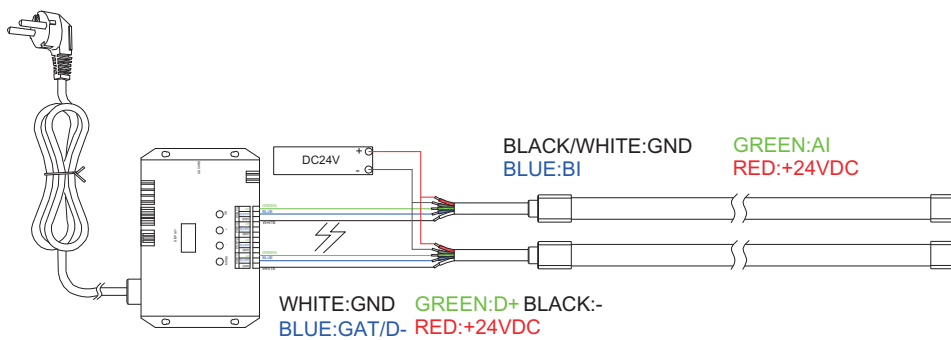

Installation Precautions

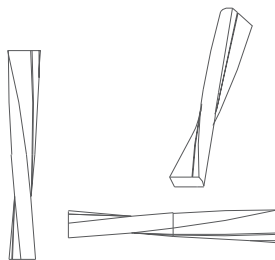

Do not twist like this.

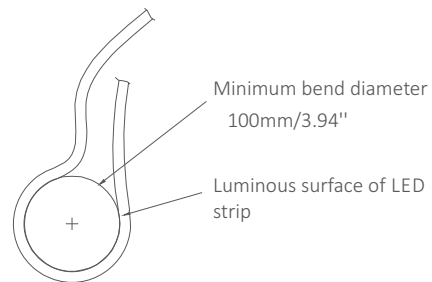

Minimum bend diameter
100mm/3.94"

Luminous surface of LED
strip

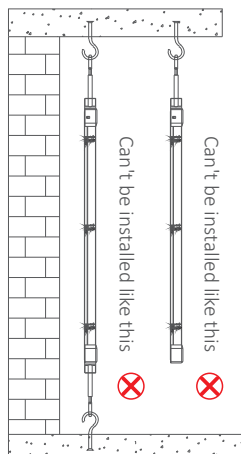

Can't be installed like this

Can't be installed like this

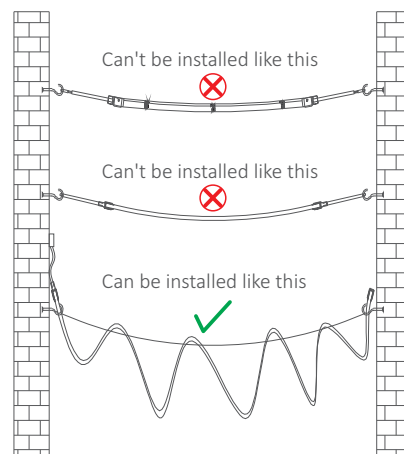

Can't be installed like this

Can't be installed like this

Can be installed like this



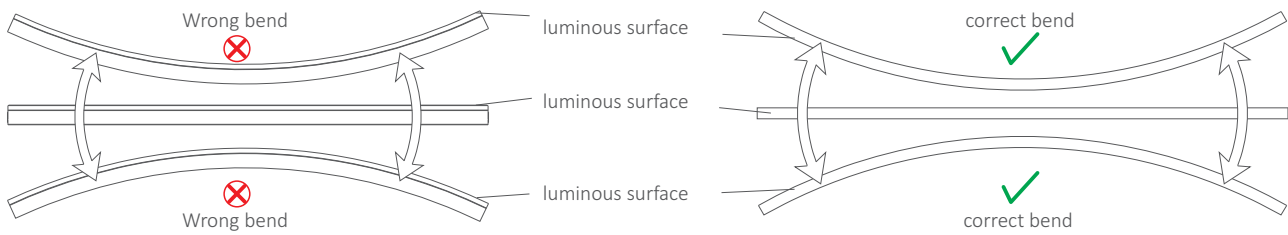

Packaging information

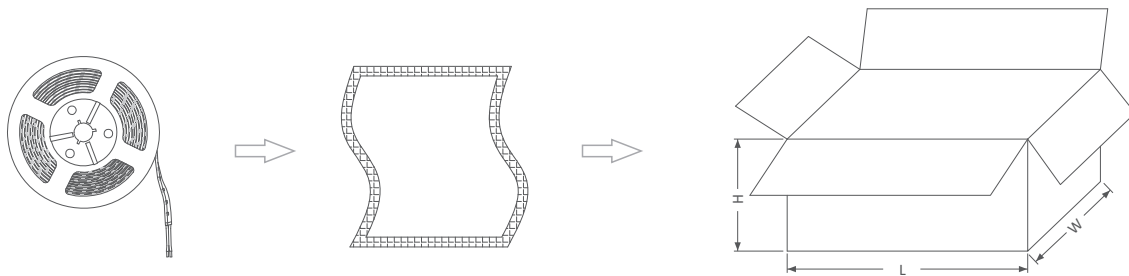

LED strip+accessories	Anti-static bag	Packing Box		
Part Number	Gross Weight per Reel	QTY per Carton	Size(cm/inch)	Gross Weight
SC-DMX512-RGBW-24V SC-DMX512-RGBNW-24V SC-DMX512-RGBWW-24V	1.55Kg	10 Reels	41cm*36cm*37cm 1.61"*1.42"*1.46"	16.22Kg

Installation requirement

- The strip itself and all its components may not be mechanically stressed;
- Routes on the circuit board can't be damaged or destroyed during installation;
- Installation of LED ribbon (with power supplies) needs to be made with regard to all applicable electrical and safety standards; Only qualified personnel should be allowed to perform installations;
- Correct electrical polarity needs to be observed. Wrong polarity may destroy the strip;
- Parallel connection is highly recommended as safe electrical operation mode;
- Serial connection is not recommended. Unbalanced voltage drop can cause hazardous overload and damage the strip;
- Please ensure that the power supply is of adapters power to operate the total load;
- When mounting on metallic or other conductive surfaces, there needs to be isolation points between strip and the mounting surface;
- Pay attention to standard ESD precautions when installing the strip;
- Damaged by corrosion will not be honored as a materials defect claim. It is the user's responsibility to provide suitable protection against corrosive agents such as moisture and condensation and other harmful elements;
- Caution needs to be taken while doing the connection after cutting the strip. Only authorized professionals can do the work to enable it waterproof in wet locations.



Yijia Industrial Park, Fuqian Road, Guanlan Town, LongHua, Shenzhen, Guangdong, China

Tel:+86-755-27608650
Fax:+86-755-27608651
www.signcomplex.com
sales@signcomplex.com



Application

- Stage lighting
- Lighting for festivals, events, exhibitions
- Signboard backlight
- Path contour lighting
- Landscape decoration lighting, etc