



Application

- ※ Cove lighting
- ※ Architectural lights for canopy, corridor, window, archway
- ※ Backlight or edge lighting for signage
- ※ DIY lights for home use
- ※ Path and contour marking
- ※ Decorative lights for holiday, event, show, exhibition

Great advantages

- ※ eco friendly
- ※ long life span, standard warranty 3 years
- ※ complete cut / connection accessories
- ※ no need of constant-current power feed
- ※ low power consumption
- ※ custom packing

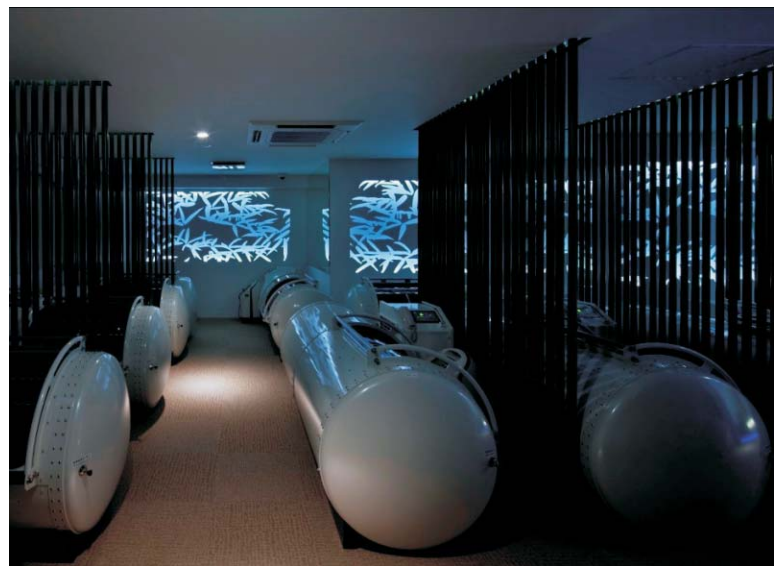

Model Number	Color	Length (m)	LED Q'ty	LED Type	Light Output (mcd/m)	Light Output (lumen/m)	Beam Angle (degrees)	Voltage (V DC)	Current (Amps/m)	Max. Power Consumption (W/m)	Continuous Connection (m)
SC-ID-W	□ White	5	300	1210/PLCC -2 SMD Top LED	60 X 1200	435	120	12	0.34-0.4	4.8	10
SC-ID-WW	□ Warm White	5	300		60 X 850	263	120	12	0.34-0.4	4.8	10
SC-ID-R	■ Red	5	300		60 X 600	115	120	12	0.34-0.4	4.8	10
SC-ID-G	■ Green	5	300		60 X 650	216	120	12	0.34-0.4	4.8	10
SC-ID-B	■ Blue	5	300		60 X 250	51	120	12	0.34-0.4	4.8	10
SC-ID-Y	■ Yellow	5	300		60 X 600	127	120	12	0.34-0.4	4.8	10
SC-ID-RGB	■ RGB	5	150	Top SMD LED 5060	30 X 1500	191	120	12	0.52-0.6	7.2	10
SC-ID2-RGB-B	■ RGB	5	300		60 X 1500	382	120	12	1.02-1.2	14.4	5

ID sery also have dampproof versions-epoxy/glue gotted and silicon sleeved

Dimension & Circuit drawings

Unit: mm (inch)

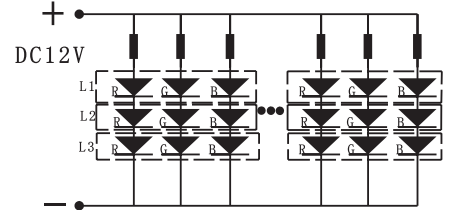
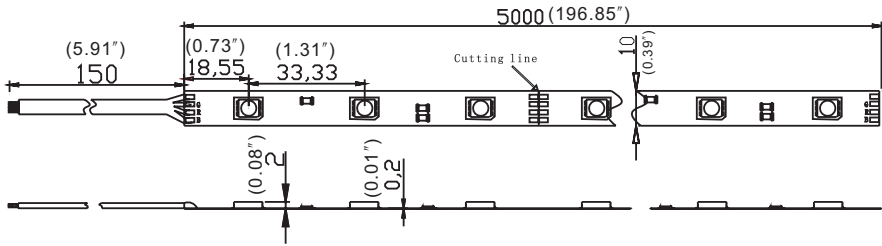
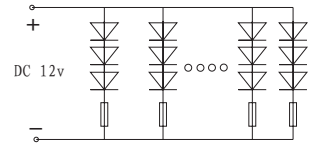
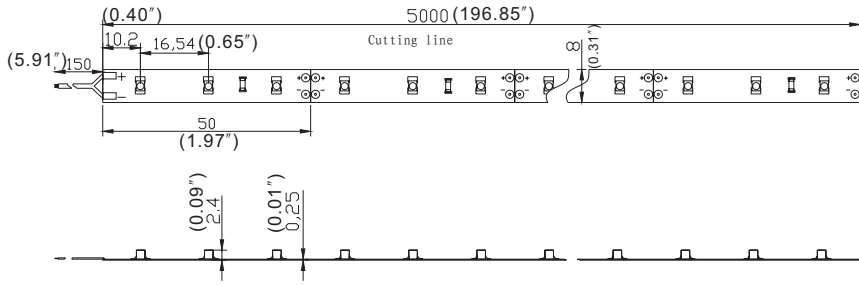

Linking operation

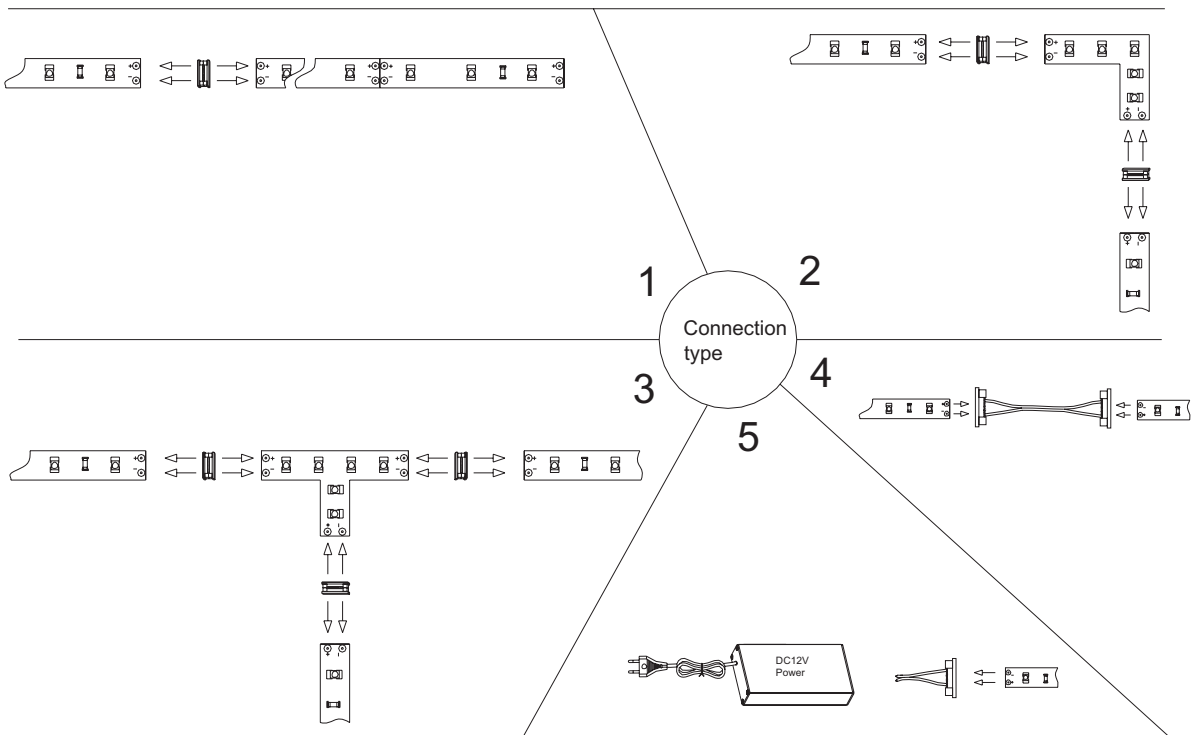
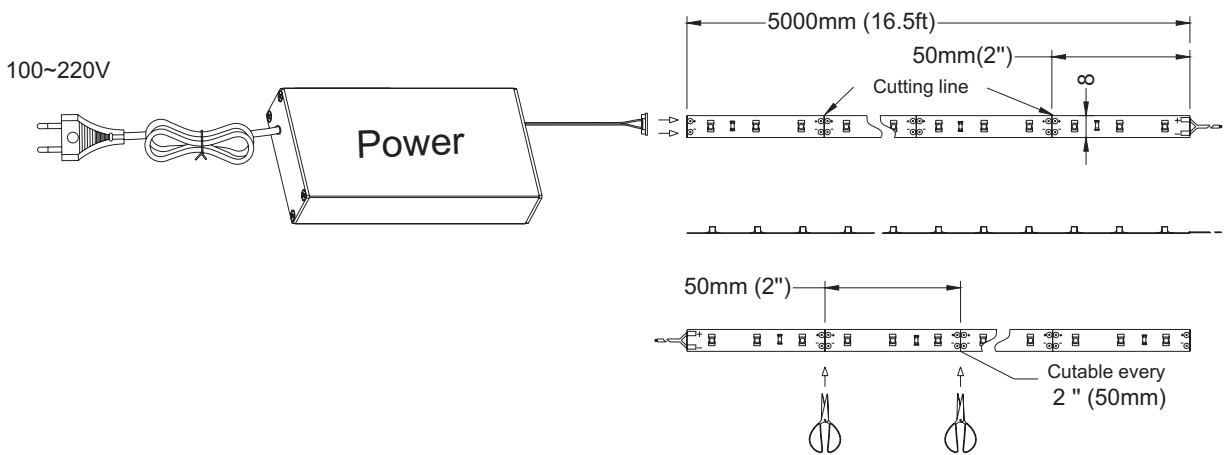

✂ installation

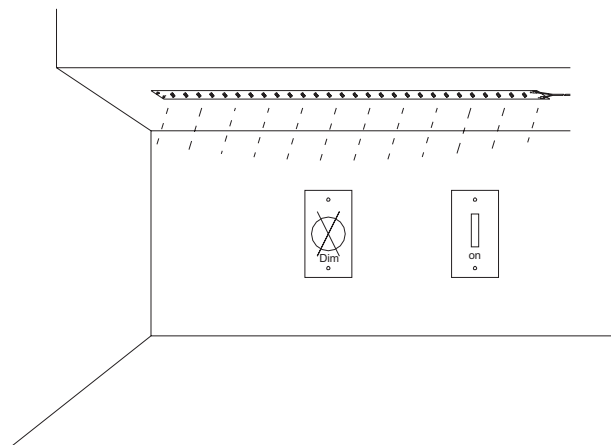
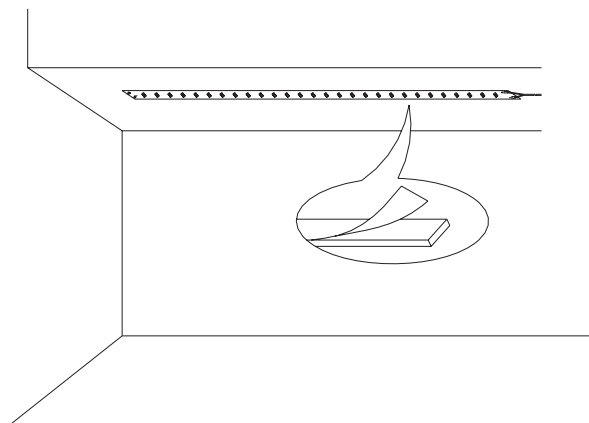

🛡 Safety Information

- The strip itself and all its components may not be mechanically stressed.
- Assembly must not damage or destroy conducting paths on the circuit board.
- Installation of LED ribbon (with power supplies) needs to be made with regard to all applicable electrical and safety standards. Only qualified personnel should be allowed to perform installations.
- Correct electrical polarity needs to be observed. Wrong polarity may destroy the strip.
- Parallel connection is highly recommended as safe electrical operation mode.
- Serial connection is not recommended. Unbalanced voltage drop can cause hazardous overload and damage the strip.
- Please ensure that the power supply is of adapters power to operate the total load.
- When mounting on metallic or otherwise conductive surfaces, there needs to be an electrical isolation points between strip and the mounting surface.
- Pay attention to standard ESD precautions when installing the strip.
- Damaged by corrosion will not be honored as a materials defect claim. It is the user's responsibility to provide suitable protection against corrosive agents such as moisture and condensation and other harmful elements.

✂ Packing information

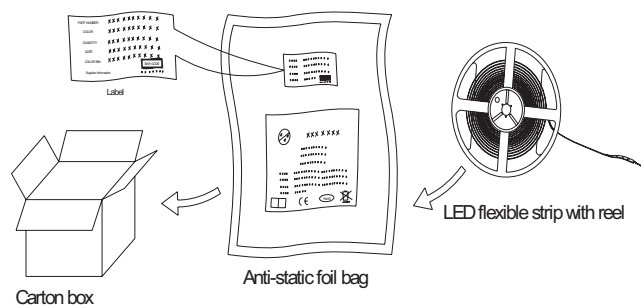

✂ Connectors

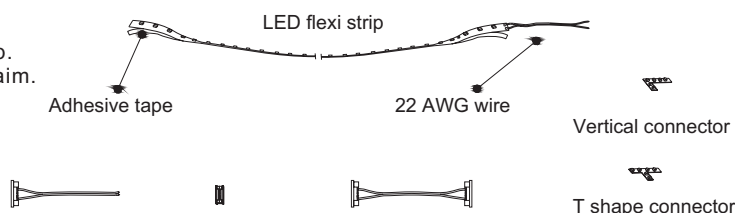

🔲 Signcomplex Limited Warranty

Signcomplex warrants this product ("Product") against defects in material or workmanship for a period of three years from the date of purchase. If this Product is determined to be defective, Signcomplex will repair or replace the Product, at its option. This warranty does not cover cosmetic damage or damage due to acts of God, accident, misuse, abuse, negligence, commercial use, or modification of, or to any part of the Product. This warranty does not cover damage due to improper operation or maintenance, connection to improper voltage supply, or attempted repair by anyone than a facility authorized by Signcomplex to service the Product.

Repair or replacement as provided under this warranty is the exclusive remedy of the customer. Signcomplex shall not be liable for any incidental or consequential damages for breach of any express or implied warranty on this Product except to the extent prohibited by applicable law, any implied warranty of merchantability or fitness for a particular purpose on this Product is limited in duration to the duration of this limited warranty.

Some states do not allow the exclusion or limitation of incidental or consequential damages, or allow limitations on how long an implied warranty lasts, so the above limitations or exclusions may not apply to you. This warranty gives you specific legal rights, and you may have other rights which vary from state to state.

Only Signcomplex may change, amend or modify the terms of this Limited Warranty and any such change, amendment or modification shall be in writing and issued by Signcomplex. To obtain warranty service and shipping information call +86 755 2760 8650 or e-mail info@signcomplex.com. You must provide proof of purchase in the form of a bill of sale or receipted invoice which is evidence that the Product is within the warranty period to obtain warranty service. Consumers have legal rights under applicable national legislation governing the sale of consumer goods. Such rights are not affected by the warranties provision outlined in this document.